

# PENTAX<sup>®</sup>

## SFX





Your Pentax camera is a high-precision 35mm SLR camera incorporating such advanced mechanisms as auto focusing, auto exposure, auto film winding and rewinding, and a built-in Retractable TTL-Auto Flash (RTF). Please read this operating manual carefully to get a good idea of the camera's functions and operations before you begin using it.



The names of the camera's working parts are listed in the nomenclature sections on the front and back flaps of this booklet, so please read this booklet with the flaps unfolded for easy reference. We hope that you will enjoy taking memorable, high-quality pictures with this remarkable camera for many years to come.





# NOMENCLATURE

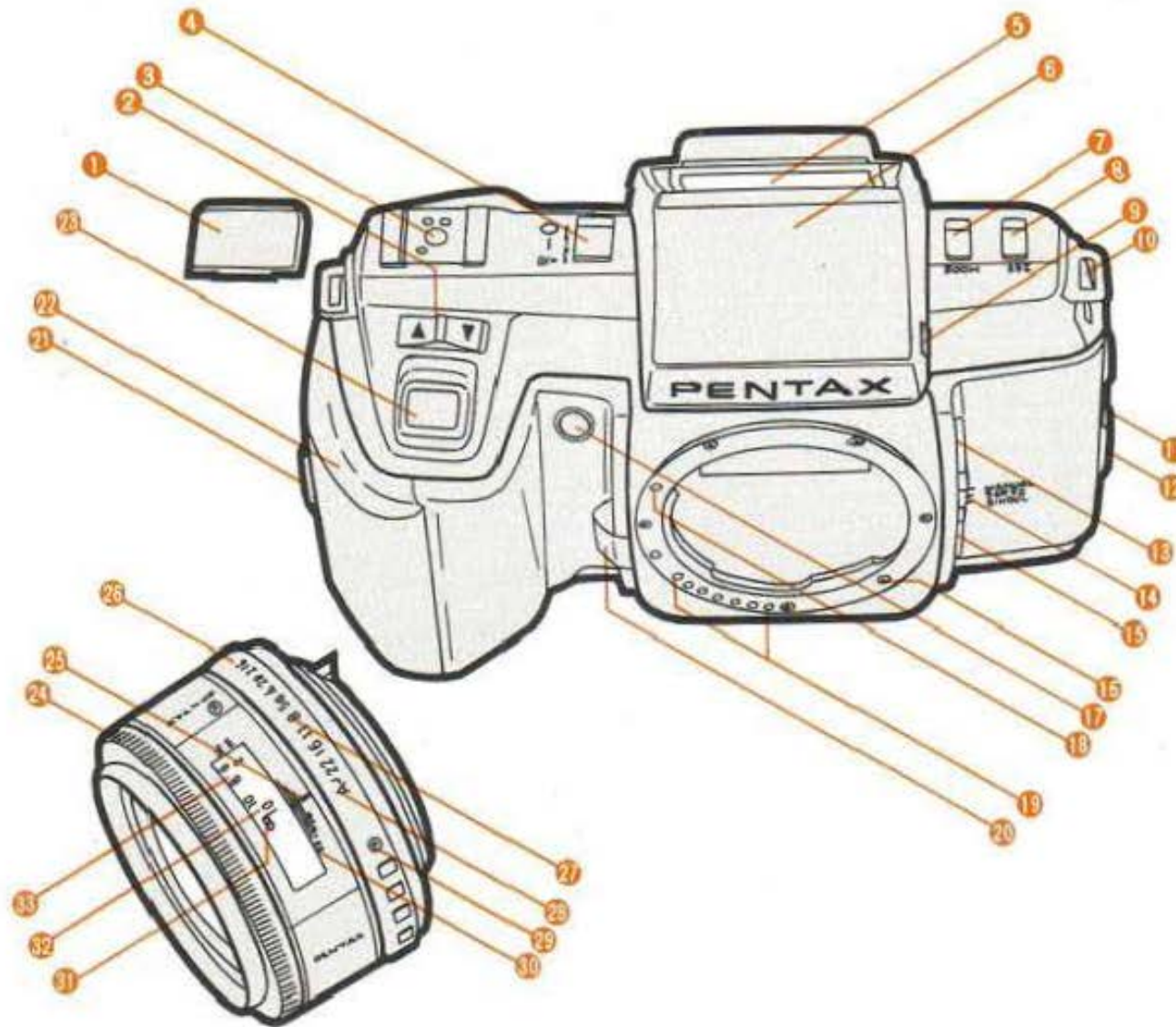

- 1 Hot-shoe cover
- 2 Select switch
- 3 Hot shoe
- 4 Main switch
- 5 CENTIC display panel
- 6 TTL auto flash (RTF)
- 7 Mode/Drive switch
- 8 ISO/Exposure-compensation switch
- 9 Flash-pop-up button
- 10 Strap lug
- 11 Back-cover-lock button
- 12 Back-cover-release lever
- 13 Release socket F
- 14 Manual-focus button
- 15 Focus-mode switch
- 16 AF coupler
- 17 Self-timer lamp
- 18 Mount index
- 19 Lens-information contacts
- 20 Lens-lock-release lever
- 21 Battery-grip screw
- 22 Lithium-battery grip
- 23 Shutter-release button
- 24 Focusing ring
- 25 Distance/Aperture index
- 26 Aperture ring
- 27 Aperture scale
- 28 Aperture-A index
- 29 Aperture-auto-lock button
- 30 Depth-of-field scale
- 31 Infrared index
- 32 Distance scale
- 33 Distance scale window



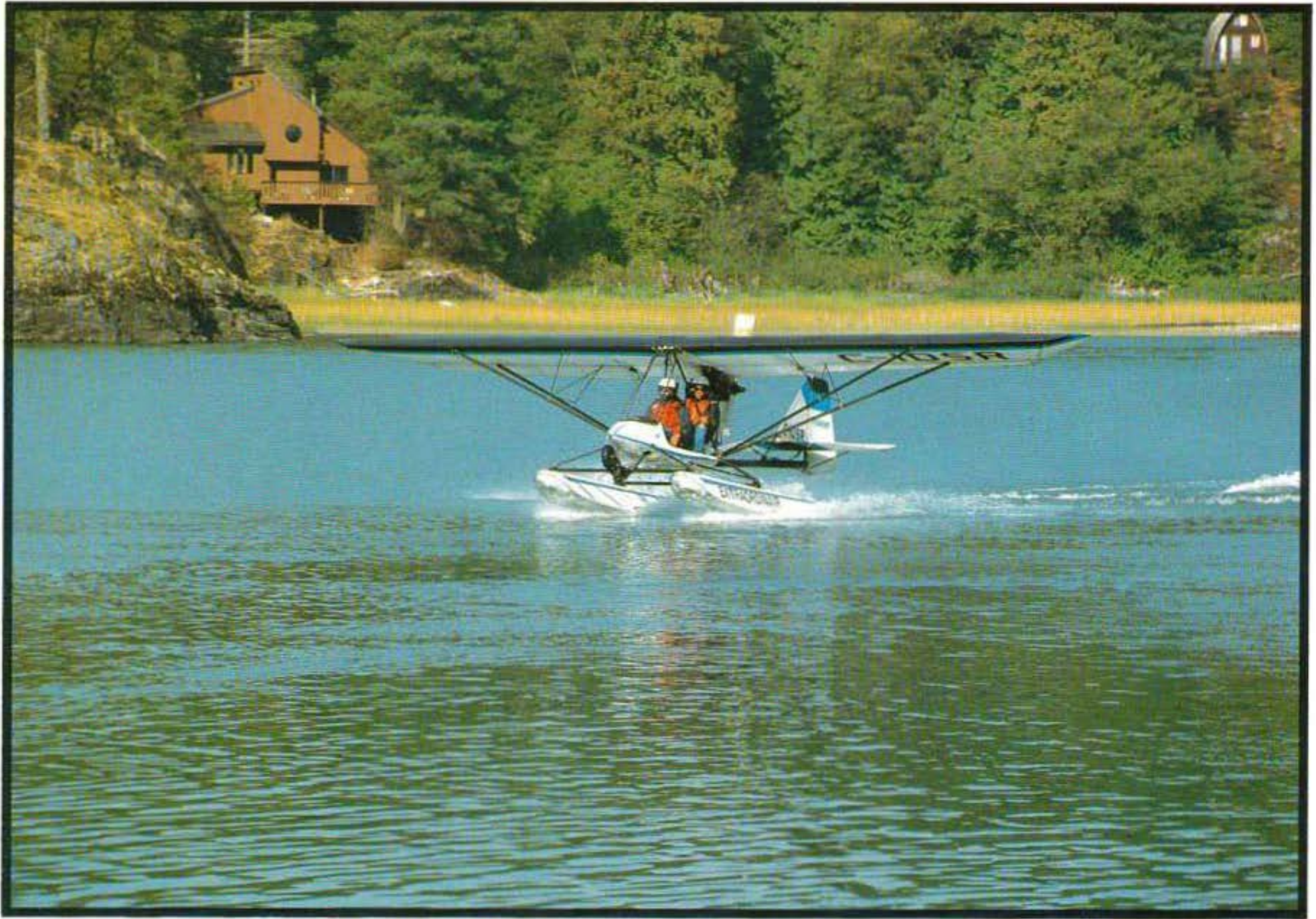



---

## TABLE OF CONTENTS

---

Before shooting and outline of operations .....	2~3	Programmed AE diagram and metering range .....	38~39
Inserting battery .....	4~5	Using a built-in flash [RTF] .....	40~42
Attaching and removing lenses .....	6	Using Pentax dedicated auto flash units .....	44~45
Main switch, shutter release button and control switches .....	7	TTL Auto Flash and Programmed Auto Flash modes .....	46~47
CENTIC display panel .....	8	Exposure memory lock .....	48
Viewfinder display .....	9	Self-timer .....	49
Usable film .....	10	Exposure compensation .....	50~51
Film loading .....	11~13	B (bulb) and 100 (1/100 sec.) settings .....	52
Setting an exposure mode with a Pentax-F lens .....	14~15	Infrared index .....	53
Shooting in the Programmed AE mode .....	16~19	Depth of field .....	54~55
Shooting in the Shutter-Priority AE mode .....	20~21	Interchangeable focusing screens .....	56
Shooting in the Aperture-Priority AE mode .....	22~23	Strap and case .....	57
Shooting in the Metered Manual mode .....	24~25	Camera's compatibility with Pentax lenses .....	58
CENTIC panel and viewfinder warnings .....	26~27	Precautions on batteries .....	59
Eyecup F and diopter adjustment .....	28	Taking care of your camera .....	60~61
Drive mode and focusing mode .....	29	Precautions on CENTIC panel's LCD display and backup circuits for LCD display .....	61
Focusing (AF SINGLE/AF SERVO) .....	30~31	Specifications .....	62~63
Focus lock .....	32	Warranty policy .....	64~65
Manual focusing .....	34~35		
Unloading film .....	36~37		

## BEFORE SHOOTING



1. Remove the battery grip and insert a lithium battery. (pages 4 & 5)

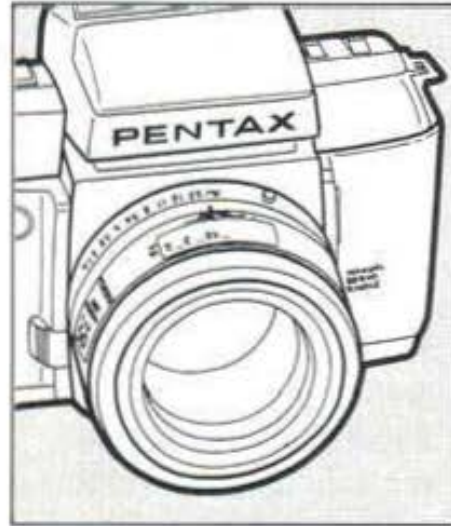

2. Attach a Pentax-F lens. (page 6)



3. Open the back cover and load the film. (pages 11~13)

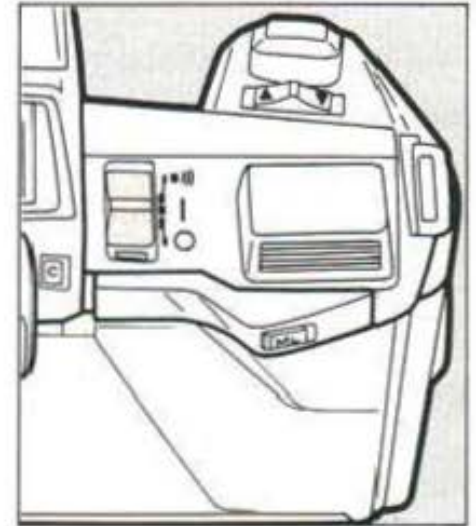

4. Turn the main switch on. (page 7)

Since this camera is an auto-focus camera, taking pictures with it is extremely simple. However, it will not operate properly if you set it up or handle it incorrectly. Perform the following operations, referring to the pages listed, before you begin taking pictures.

There are also many ways to shoot photographs with this camera. Please refer to the section about the specific mode you want to use before going on to page 3.



- After adjusting the diopter of the eyepiece to your eyesight, insert the Eyecup F into the accessory groove. (page 28)



## OUTLINE OF OPERATIONS

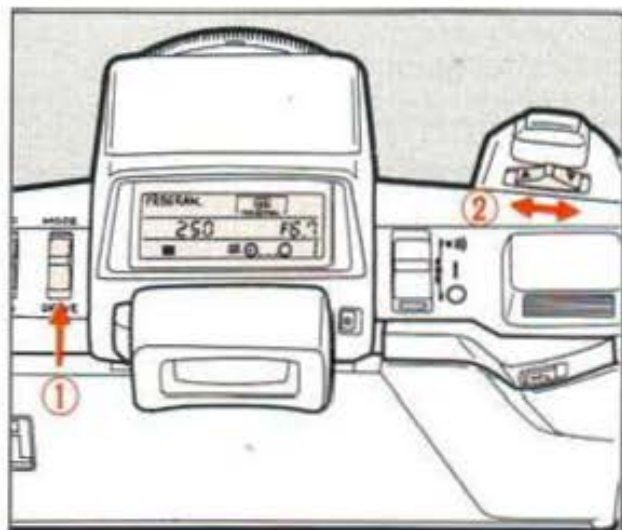

**1.** Set the desired exposure mode by sliding the select switch to the UP or DOWN position while holding the mode/drive switch at the MODE position. (pages 7 & 14~25)

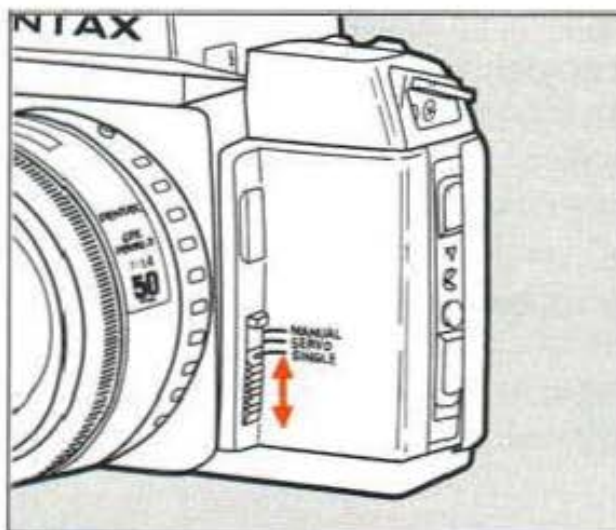

**2.** Set the focus mode switch at the SINGLE position. (page 29)  
When you press the shutter release button halfway down, the auto-focusing mechanism is activated and the lens starts moving. (pages 30~35)



**3.** Position the subject within the viewfinder's focus frame [ [ ] ].  
If the green in-focus signal [ □ ] at the bottom of the viewfinder lights up when you press the shutter release button halfway down, the subject is in focus. (pages 30~35)

● After shooting the designated number of frames, rewind the film into its cartridge and take it to a photo service for development as soon as possible. (pages 36 & 37)

INSERTING BATTERY

This camera comes equipped with the standard Lithium Battery Grip. For this grip, use one 6V lithium battery (National/Panasonic BR-P2DP, Duracell DL223A, Eveready EL2CR5 or Sanyo 2CR5). (If any other type of lithium battery is used, the battery-warning mark may appear on the CENTIC (Central Information Cluster) display panel, since it is inferior in characteristics to those listed above.)

(Lithium Battery Grip)

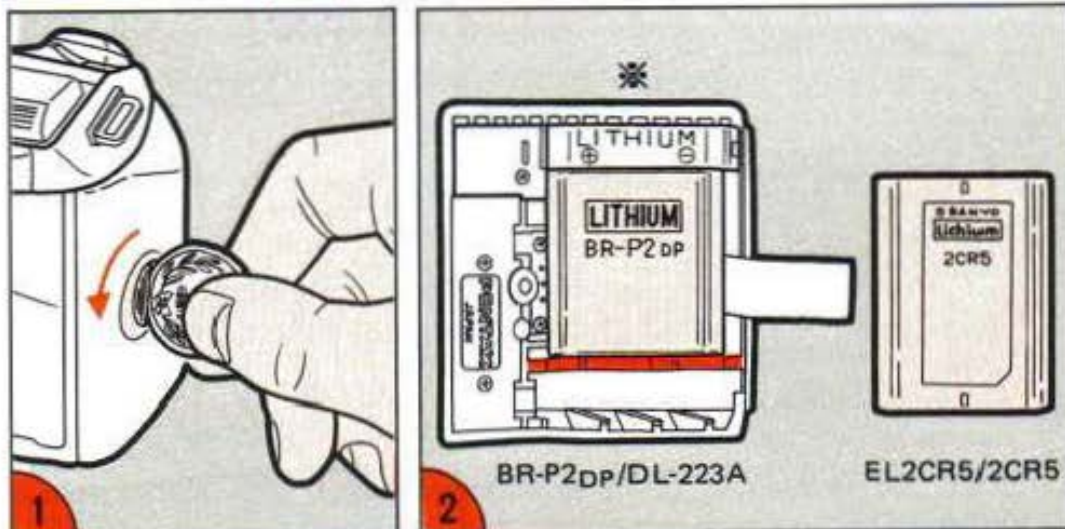

• When you attach or detach the battery-loaded Grip, all the indicators will appear on the CENTIC display panel, and the flash-ready lamp will also light up.

※ NiCd batteries cannot be used with the SFX.

1. Remove the grip by turning its mounting screw counterclockwise with a coin.
2. Position the lithium battery properly by matching its polarity marks ("+" and "-") with those inside the grip, then mount the grip at the original position. (The old battery can easily be removed by pulling the band.)

※ Insert BR-P2DP and DL-223A within the inner frame of the battery chamber as shown above.



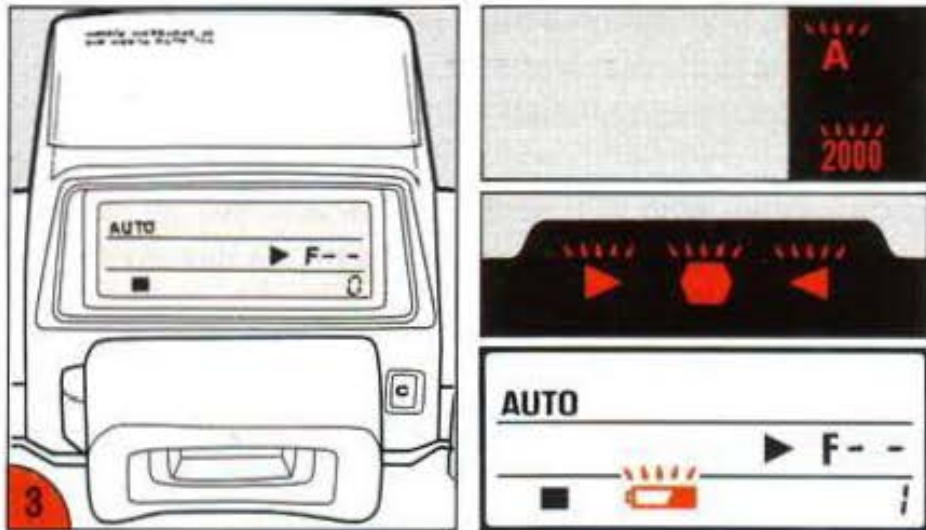

3. As illustrated, the CENTIC panel shows the selected exposure mode. If the panel remains inactive or all its indicators light up, the battery is either exhausted or not inserted properly, so check it again.

#### \*Battery Warning Mark

When the battery weakens, the battery warning mark [☹] on the CENTIC panel and the viewfinder indicators will start blinking to inform you of this condition. Replace the battery as soon as possible. If the battery drops below the required voltage, the shutter release button will lock automatically, and the indicators on the CENTIC panel will all light up.

#### ("AA"-size Battery Grip)

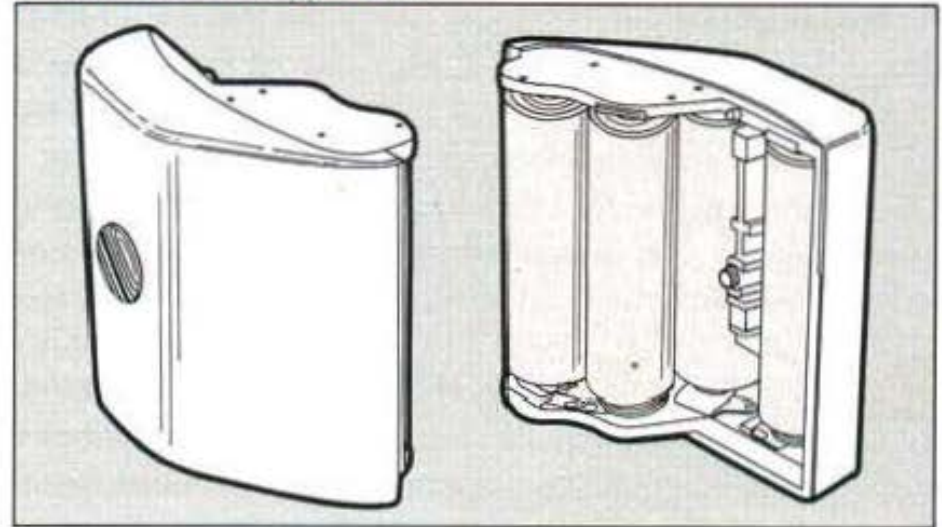

As illustrated, the "AA" Battery Grip (optional) can be used with four "AA"-size alkaline batteries of the same type. Make sure they are inserted properly.

- "AA"-size manganese batteries are also usable. However, their power supply is limited and use of alkaline batteries is recommended.



## ATTACHING AND REMOVING LENSES

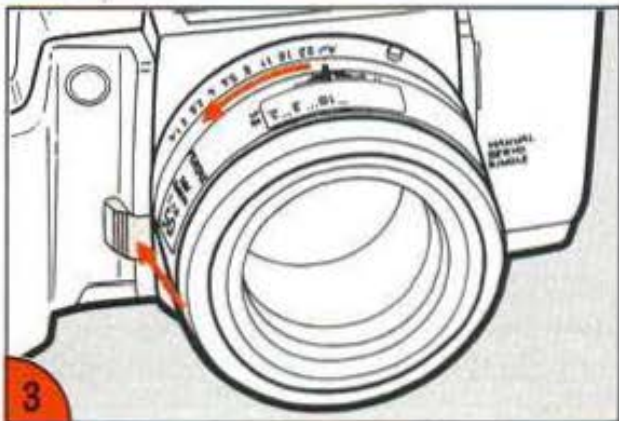
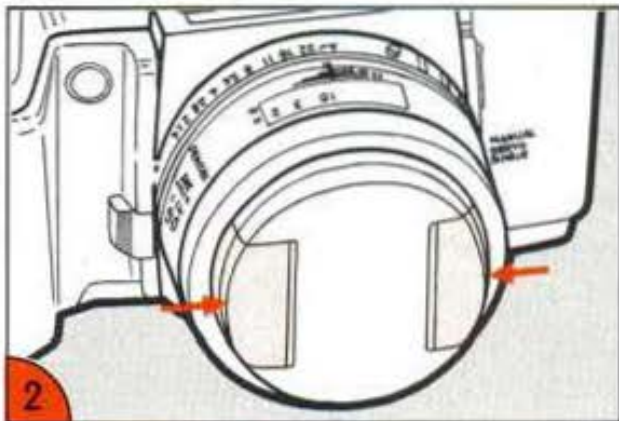
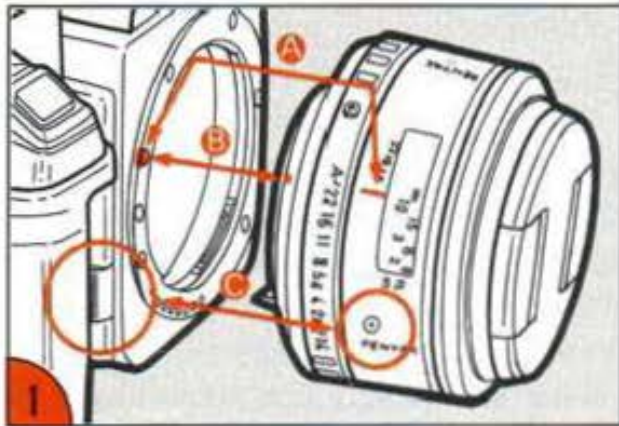

Read this section even if the lens is already mounted on the camera.

- Remove the body-mount cap and the rear lens cap.

The Body-Mount Cap F and the Lens-Mount Cap K are available as options.

1. Align the red dot on the camera with the red dot on the lens (see **A** and **B**), place the lens onto the camera's lens mount, and turn it clockwise until the lens locks with a click. When mounting the lens by touch under dim light, method **C** is recommended.
2. To remove the lens cap, press in the tabs on both sides.
3. To remove the lens, turn it counterclockwise while pressing the lens release lever toward the camera body.

- Attach the front and rear lens caps on the detached lens to protect it from dust and scratches. The lens should be set down with the front lens side down, as illustrated.

\* If a Pentax-A or -M lens is mounted directly onto the camera, it can be used only in the manual-focus mode (page 34). It can also be used as an auto-focus lens in combination with the AF Adapter 1.7X (optional).

\* Old Screw-mount Takumar lenses can be used with the Mount Adapter K (optional). However, focusing must be made using the viewfinder's matte area.

Do not damage or stain the lens information contacts or the AF coupler on the mount surfaces of the camera and the lens. If this occurs, wipe them gently with a clean dry cloth.



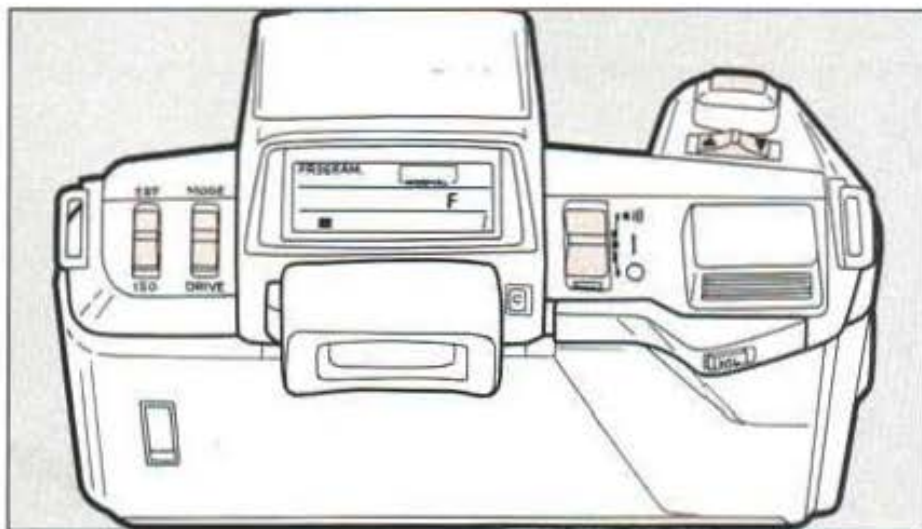

## Main Switch

Whenever setting an exposure mode or releasing the shutter, make sure you turn the main switch on [ I • ● ] first. Turn it off [ ○ ] when you are not using it to avoid accidental shutter releases.

- When the main switch is set at the [ ● ] position, a PCV tone will inform you of correct focusing and self-timer operation.

## Control Switches

The mode/drive and ISO/exposure compensation switches can be operated by moving the switch to the desired position (MODE or DRIVE,  $\pm$ EF or ISO) and sliding the select switch to the UP or DOWN position. The select switch is also used to set a shutter speed.

**MODE** = Exposure mode (Programmed AE, etc.)

**DRIVE** = Self-timer, single advance, consecutive advance

$\pm$ EF = Exposure compensation

ISO = Film speed

## Shutter Release Button

When the main switch is turned on and the shutter release button is pressed halfway down, the auto-focusing and light-metering mechanisms are activated, and the CENTIC panel and viewfinder display indicators light up. (The indicators remain on for approximately 10 seconds even after the shutter release button is released.) To release the shutter, press the shutter release button all the way down.

- If you press the shutter button with the back cover open, the shutter will be released at a fixed speed.



# CENTIC DISPLAY PANEL

## CENTIC Indications

- Shutter speed indication: from 1/2000 second to 30 seconds ("2000" ~ "30") for the Programmed AE and Aperture-priority AE modes, and from 1/2000 second (2000) to 1 second (1) for the Shutter-Priority AE and Metered Manual modes.
- F-number indication: from f/1.2 to f/90 in 1/2 steps.
- ISO film-speed indication: from ISO 6 to ISO 6400 in 1/3 steps.

- Exposure compensation indication: from -4 to +4 in 1/2 steps.
- Exposure counter indication: from 0 to 99.

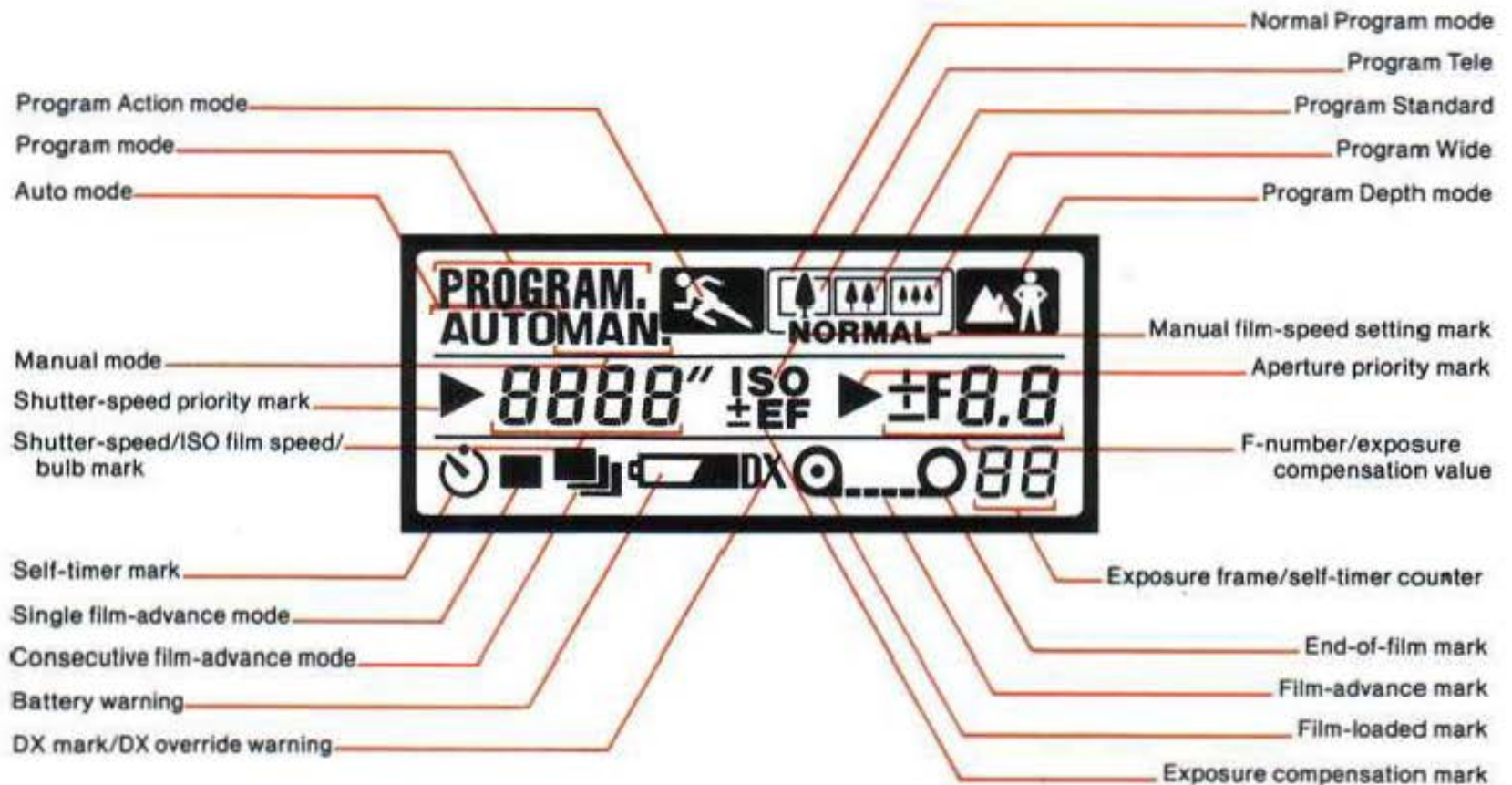

# VIEWFINDER DISPLAY

## Viewfinder Indications

- [ ] Focus frame indicator
- ▶ ◯ ◀ Focus indicator (front-focus, in-focus and back-focus signals)
- ⚡ Flash-ready indicator (A flash-ready indicator for the built-in RTF is located next to the viewfinder eyepiece)
- M Metered Manual indicator
- A Shutter-Priority AE/Aperture-Priority AE indicator
- P Programmed AE indicator
- 2000~2 Shutter speed indicator ("2000" for 1/2000 second and "2" for 1/2 second)
- LT Long-Time exposure indicator
- ±EF Exposure compensation indicator

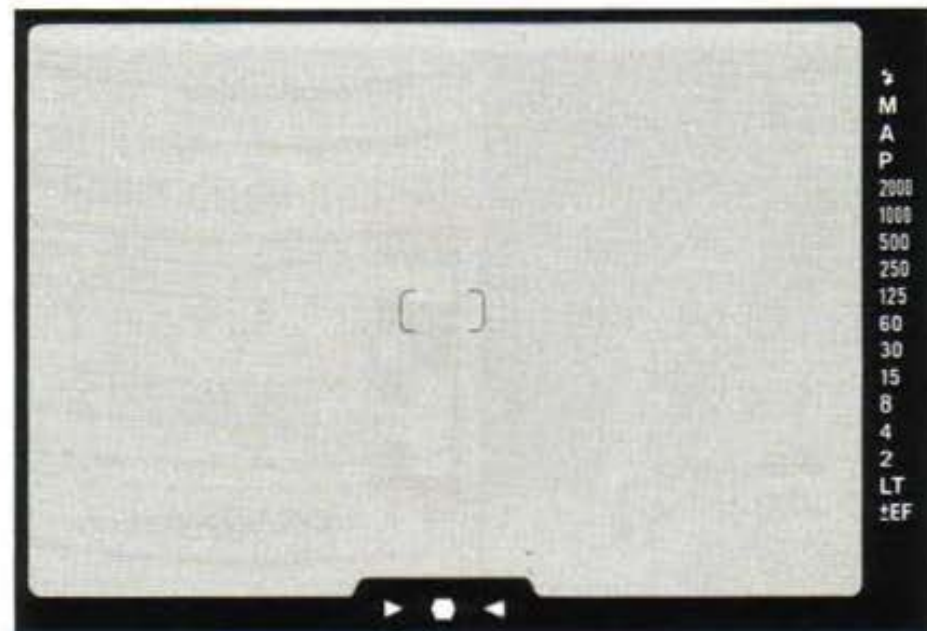



## USABLE FILM (DX-coded film and non-DX-coded film)

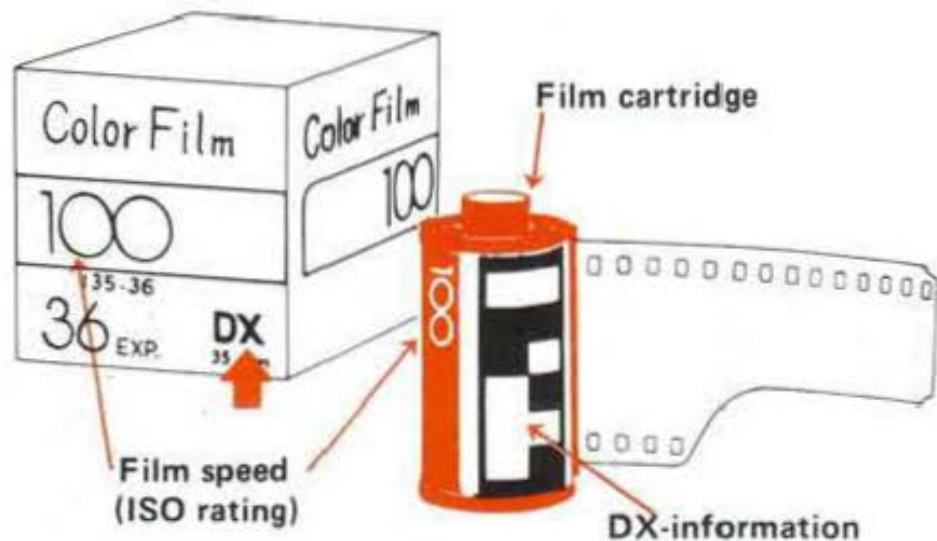

### DX-Coded film

When DX-coded film is loaded in the camera, the ISO film speed is set automatically. This type of film will have a DX mark on its package and/or a DX information panel on its cartridge.

- The automatic ISO film-speed setting for DX film is available only for film with an ISO rating between 25 and 5000, so make sure you use film in this range.
- If the automatic ISO film-speed setting for DX film is cancelled by the override mechanism described at right, the DX mark on the CENTIC panel will blink to warn you.

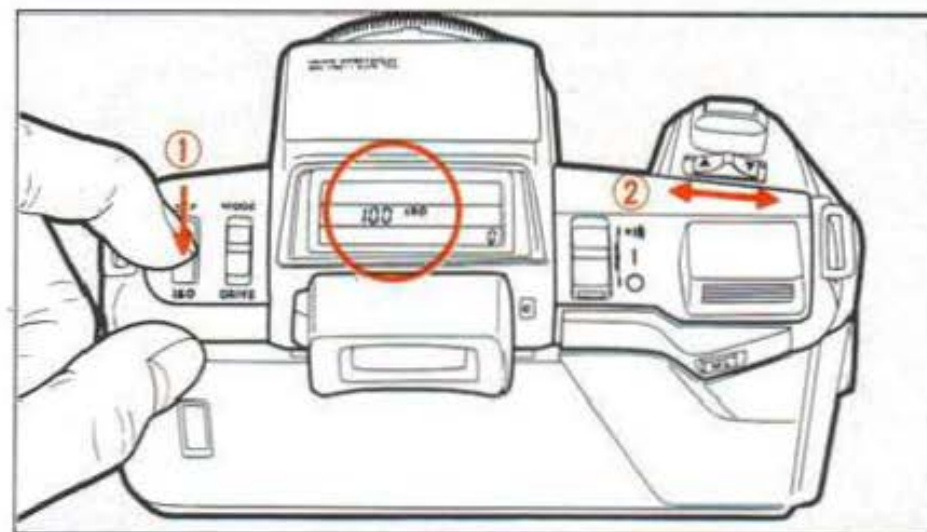

### Non-DX-Coded Film

When loading film that is not DX-coded, make sure you set the ISO film speed indicated on the package manually. When the ISO/exposure compensation switch is pushed to the ISO position, the ISO film speed of the film used previously is indicated on the CENTIC panel. While holding the compensation switch at this position, slide the select switch to the UP or Down position to set the desired film speed. One move of the select switch either increases or decreases the film speed by 1/3 of a step in the range between ISO 6 and ISO 6400. If the select switch is held at one position, the speed is changed continuously.

**UP:** Heightens the sensitivity of the film, up to ISO 6400.

**DOWN:** Lowers the sensitivity of the film, down to ISO 6.

## FILM LOADING

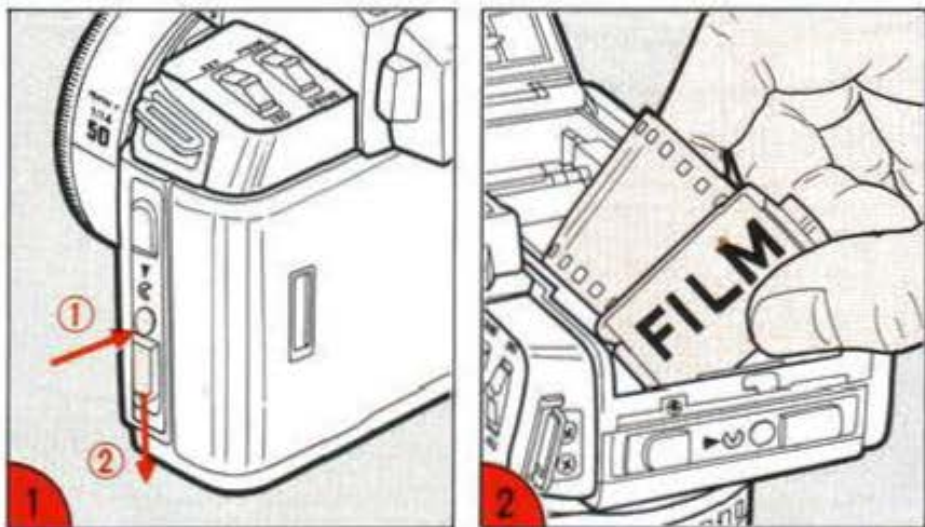

Always load or unload film in a shady spot, or shield it from direct sunlight with your body.

1. Open the camera's back cover by sliding down the back-cover release lever while depressing the back-cover lock button.
2. A film cartridge can be easily inserted by sliding its upper part into the film chamber first.

The DX-information pins are very important for correct automatic ISO film speed setting. Do not bend them, and keep them free from scratches, stains, dirt and dust.

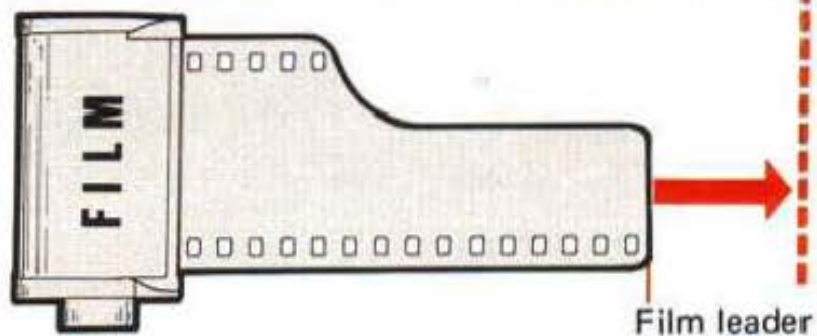
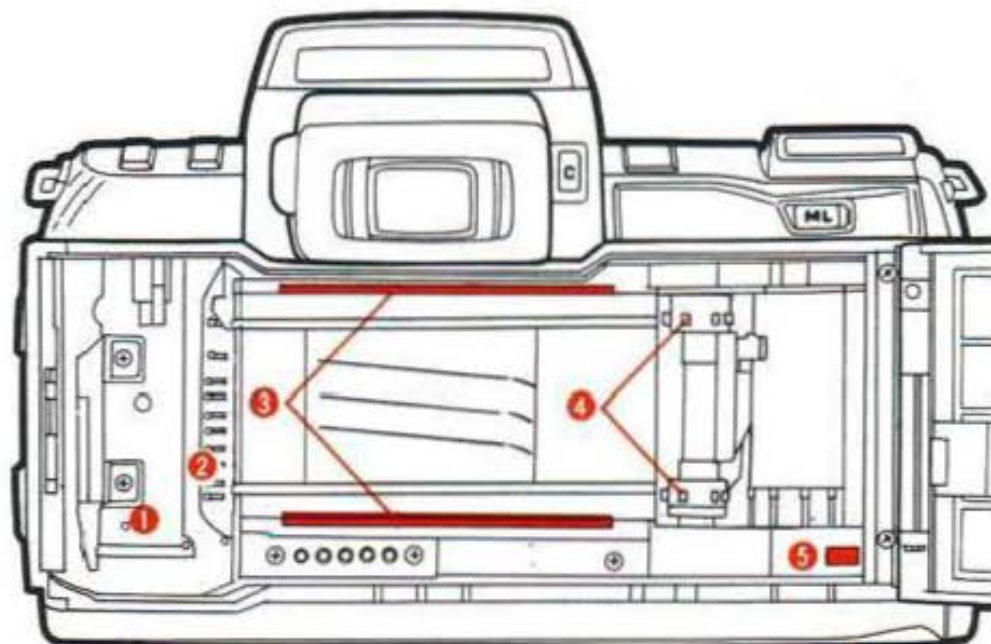

- 1 Film chamber
- 2 DX-information pins
- 3 Guide rails
- 4 Sprocket teeth
- 5 Film loading mark



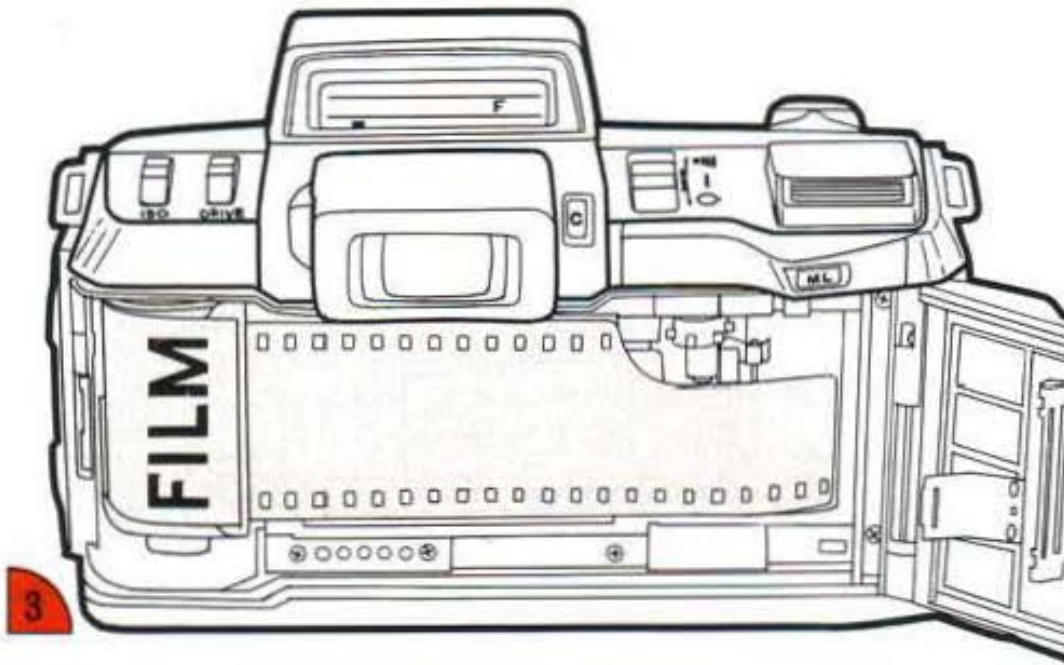

3. As illustrated, pull the film leader out until its end aligns with the film loading mark of the camera body.

- Do not leave the film slack.
- If the film leader is sharply bent, straighten it or cut it out before loading.

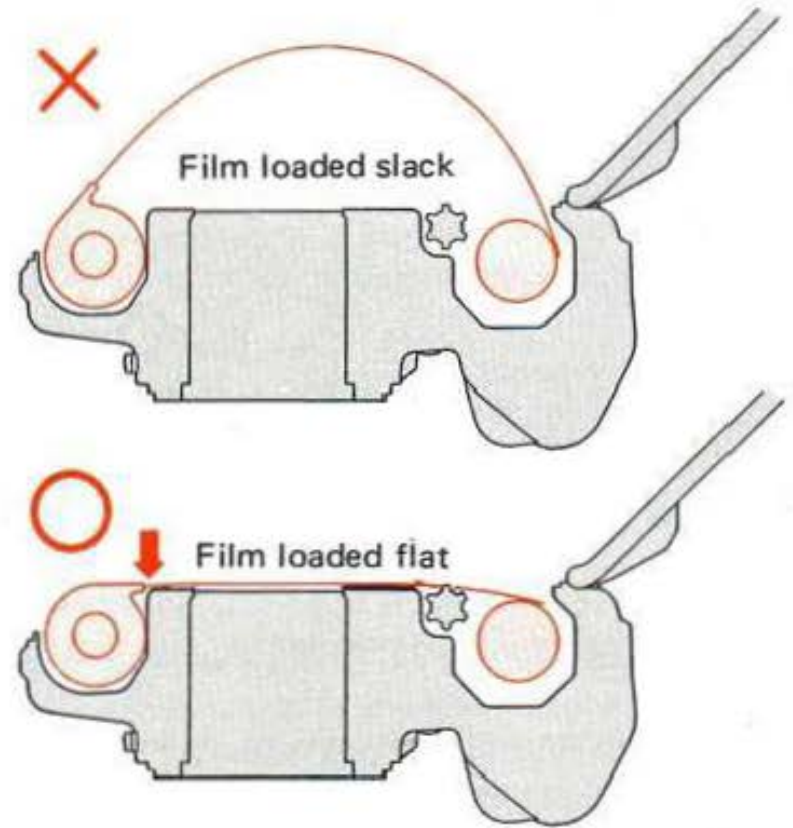

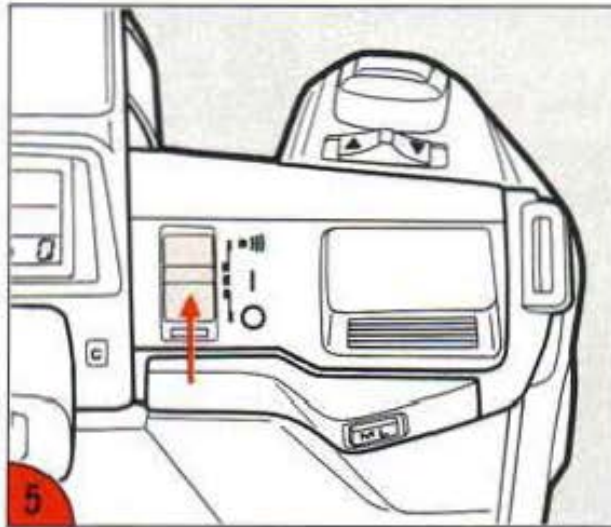
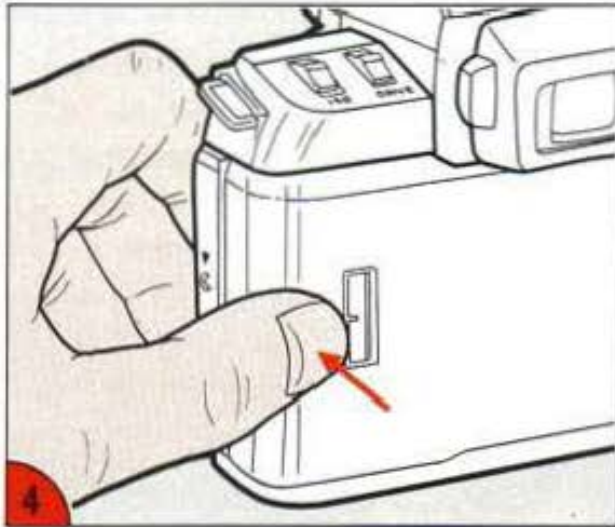

4. Close the back cover, as illustrated.
  5. Turn the main switch on. The shutter automatically releases to advance the film to the first frame.
- The type of film loaded in the camera can be checked in the film information window.
  - The film is advanced to the first frame, even if the back is closed after the main switch is turned on.

6. Film advance automatically stops when the exposure counter reaches the first frame, and the CENTIC panel appears as it does above. The film-loaded mark lights up, and the film-advance and end-of-film marks blink each time the film is advanced to the next frame.

If the film-loaded, film-advance and end-of-film marks do not appear on the CENTIC panel, the film is not loaded properly. Open the back cover and reload the film.



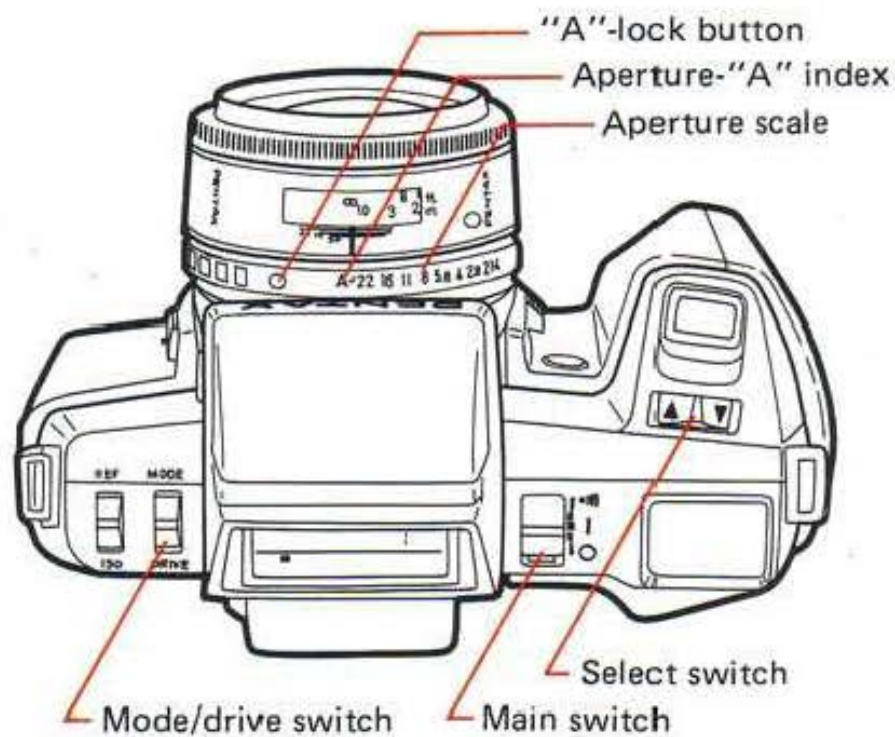

## Setting and Releasing the Auto Lock

To set the lens aperture ring to the "A" (Auto) position as in the illustration at left, align the ring's aperture-"A" index (green line) with the distance/aperture (red line) index while pressing the "A"-lock button. To release the auto lock, turn the ring to the desired f-number (except "A") while pressing the "A"-lock button.

- Press the aperture auto lock button only when turning the ring from the "A" position to the largest f/number (f/22 in this case) or vice versa.

The following exposure modes can be set depending on the position of the aperture ring:

- "A" setting:**
- Programmed AE (Program Action) (Normal Program) (Program Depth)
  - Shutter-Priority AE
- Any f-number:**
- Aperture-Priority AE
  - Metered Manual
  - 100 (fixed at 1/100 sec.)
  - Bulb

### Setting an Exposure Mode

To set an exposure mode, turn the main switch on [ I • • ] . Then, slide the select switch to the UP or DOWN position while pressing the mode/drive switch to the desired mode position. One move of the select switch changes the mode once, and the mode is shifted continuously if the switch is held at the position. The selected mode is indicated on the CENTIC panel each time the mode is shifted. The chart at right indicates how the CENTIC panel indicators shift.

### Setting a Shutter Speed

In the Shutter-Priority AE and Metered Manual modes, the desired shutter speed can be selected by sliding the select switch to the UP or DOWN position. One push of the switch changes the shutter speed to the next setting, and the shutter speed can be changed continuously if the switch is held at one position. The changes are indicated on the CENTIC panel. The indication stops at "2000" (1/2000 sec.) for the UP position and at "1" (1 sec.) for the DOWN position.

### With the aperture ring set at "A"

Up position    Down position

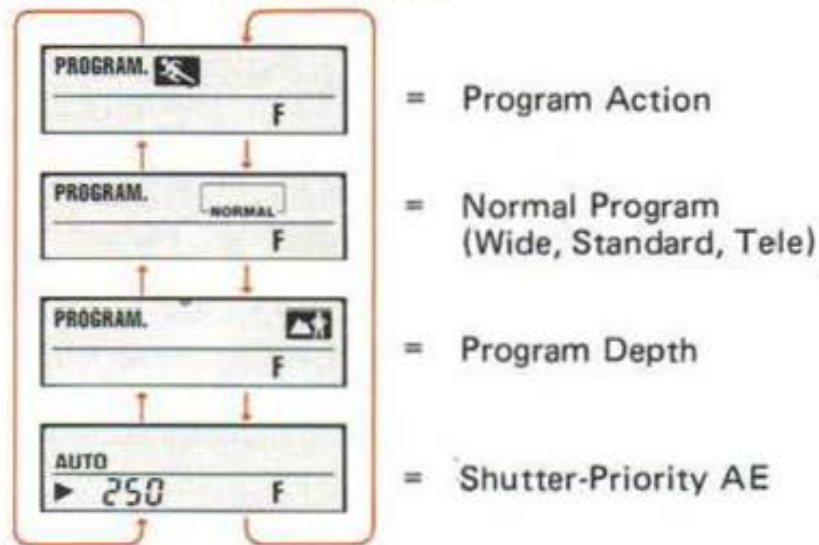

### With the aperture set at any f-number except "A"

Up position    Down position

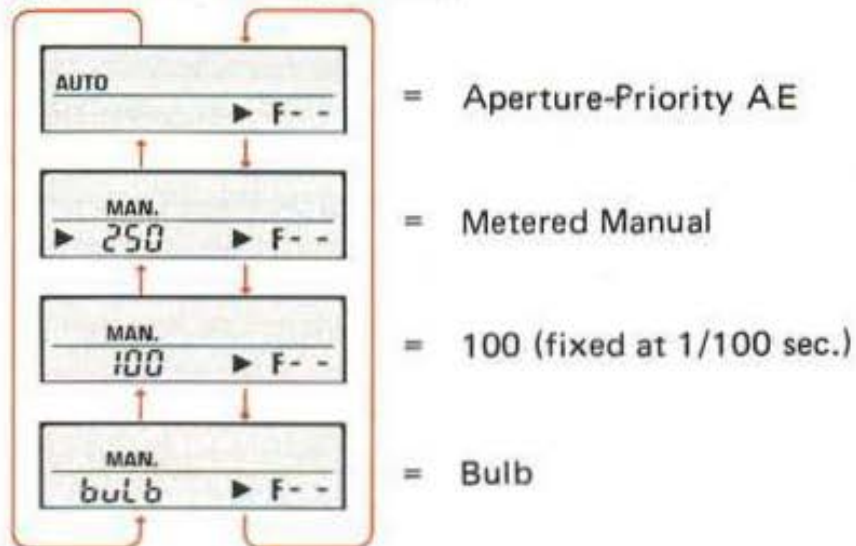



### Exposure Modes When Aperture Ring is Set at "A"

- Programmed AE modes
  - Program Action
  - Normal Program
  - Program Depth
- Shutter-Priority AE mode

● The exposure modes mentioned above can be used only in combination with SMC Pentax-F or -A lenses.

### Programmed Auto Exposure System

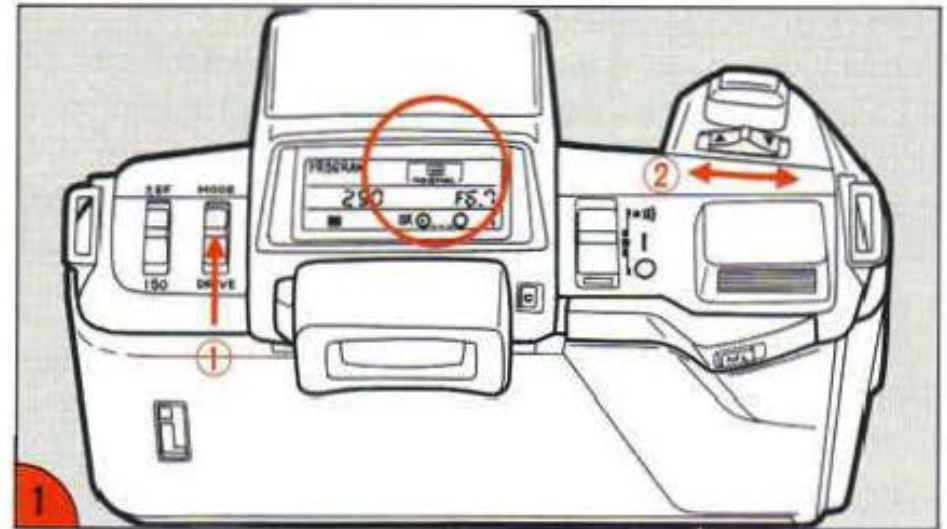

The camera automatically selects the optimum combination of aperture and shutter speed to ensure correct exposure according to the lighting conditions surrounding the subject. The Programmed AE modes free you from complicated exposure controls and allow you to concentrate on the subject, so take advantage of them for standard shooting and in situations when shutter speed is crucial. This camera features three Programmed AE modes suitable for a wide range of photographic situations.

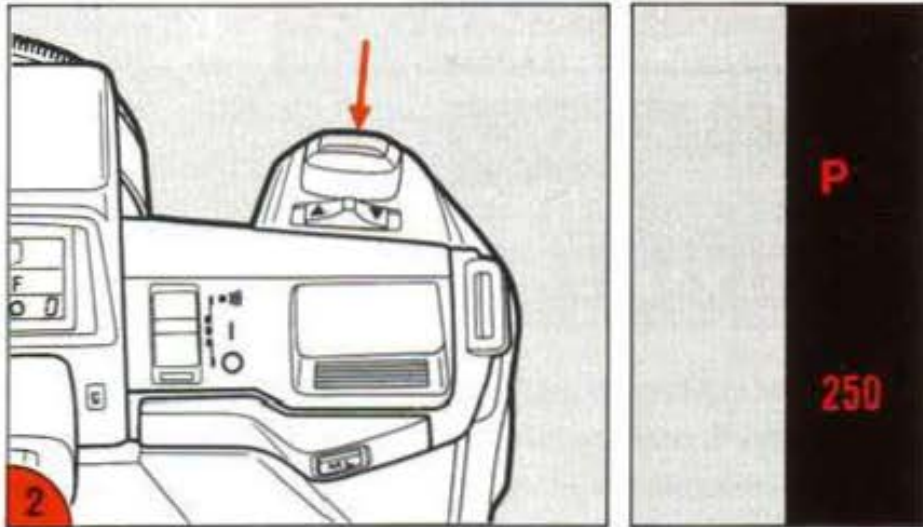

1. When the Programmed AE mode is selected, the CENTIC panel confirms it by activating the [PROGRAM] indicator and one of three other indicators – [ ] for Program Action, [NORMAL] for Normal Program and [ ] for Program Depth. Set the desired Programmed AE mode by moving the select switch to the UP or DOWN position while pressing the mode/drive switch at the MODE position.



- When you press the shutter release button halfway down, the camera displays "P" and a shutter speed in the viewfinder, as well as a shutter speed and aperture value on the CENTIC panel.

- When the Normal Program mode is selected, the CENTIC panel also displays a sub-mode indicator ([  ], [  ] or [  ]), depending on the focal length of the lens in use.

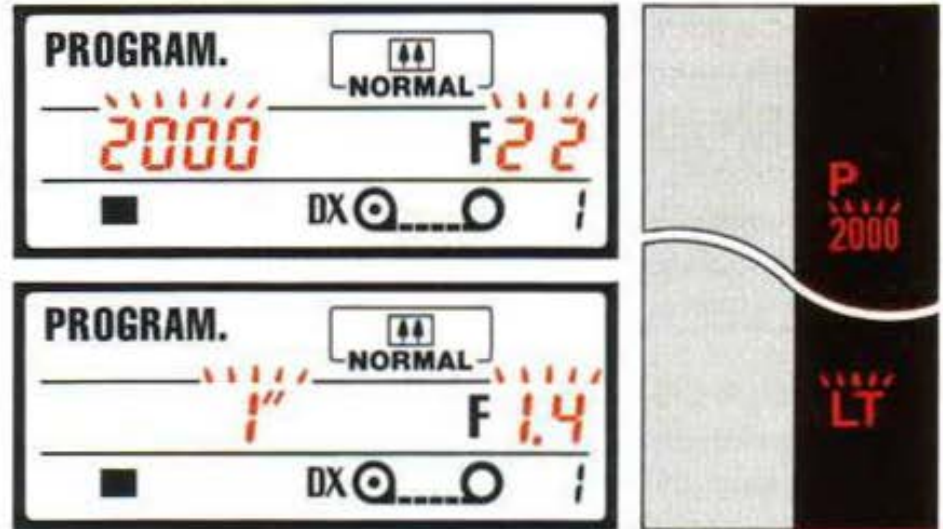

#### Programmed AE Mode Warnings

If the subject is too bright or too dark, the viewfinder and CENTIC indicators blink to warn you. When the selected shutter speed is 1/30 second or slower (shown by orange indicators in the viewfinder), the use of a flash or tripod is recommended to avoid camera shake. (See page 26 for more detailed information on warnings.)



## Normal Program Mode

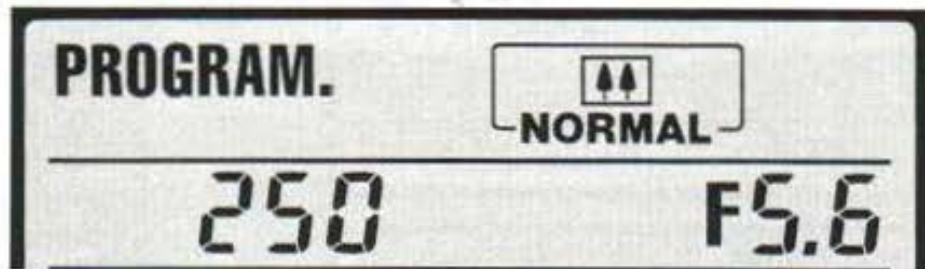

When the Normal Program mode is selected, the camera automatically sets one of the sub-modes (Wide [W], Standard [S] or Tele [T]), depending on the focal length of the lens in use. The sub-mode is also automatically switched when the focal length of the zoom lens changes. When the macro setting of a zoom lens is used, the Normal Program Tele [T] is automatically set.

When an SMC Pentax-A lens is used, the camera automatically selects the Normal Program Standard mode.

### Normal Program Sub-Modes and Lens Focal Lengths

Sub-mode	Focal length of lens
Wide [W]	Shorter than 40mm
Standard [S]	Between 40mm and 110mm
Tele [T]	Longer than 110mm

## Program Action Mode



This mode is programmed to select a relatively high shutter speed, making it ideal for action shooting such as sports and wildlife photography. It also minimizes camera shake and vibration to prevent blurred images.

## Program Depth Mode

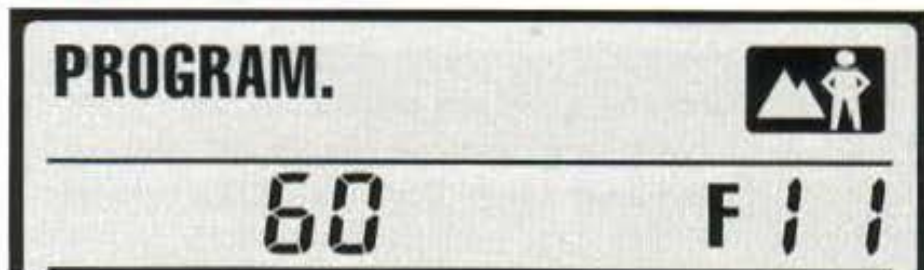

This mode is programmed to maximize the depth of field. Use it for subjects requiring both near and distant elements to be in sharp focus, such as portrait shots with a background setting (buildings, landscapes, etc.), or taking close-ups.

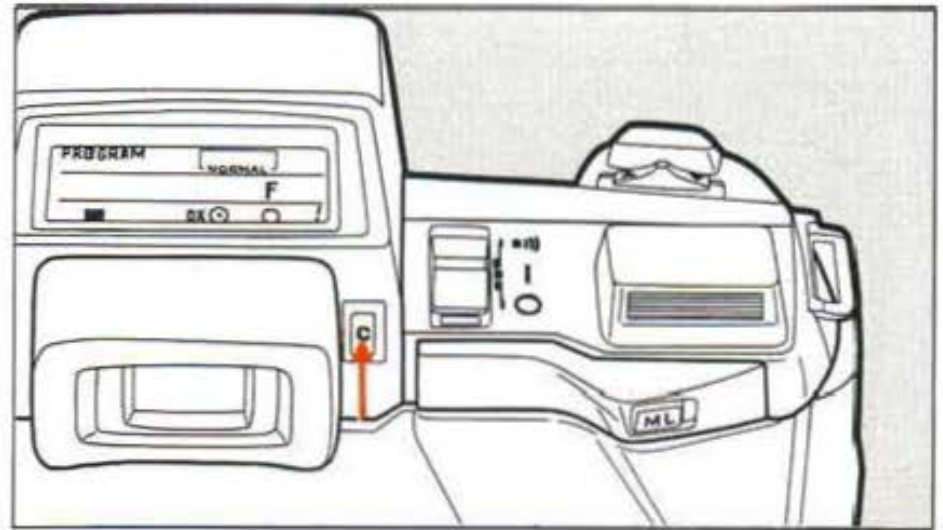

### Exposure Mode Clear Button

Pushing this button instantly resets all the current settings (exposure mode, drive mode, exposure compensation, etc.) to the settings described below.

<b>Exposure Mode:</b>	Lens at "A" setting	→ Normal Program
	Lens at any f-number	→ Aperture-Priority AE
<b>Drive Mode:</b>		→ Single Advance
<b>Exposure Compensation:</b>		→ ±0.0



## SHOOTING IN THE SHUTTER-PRIORITY AE MODE

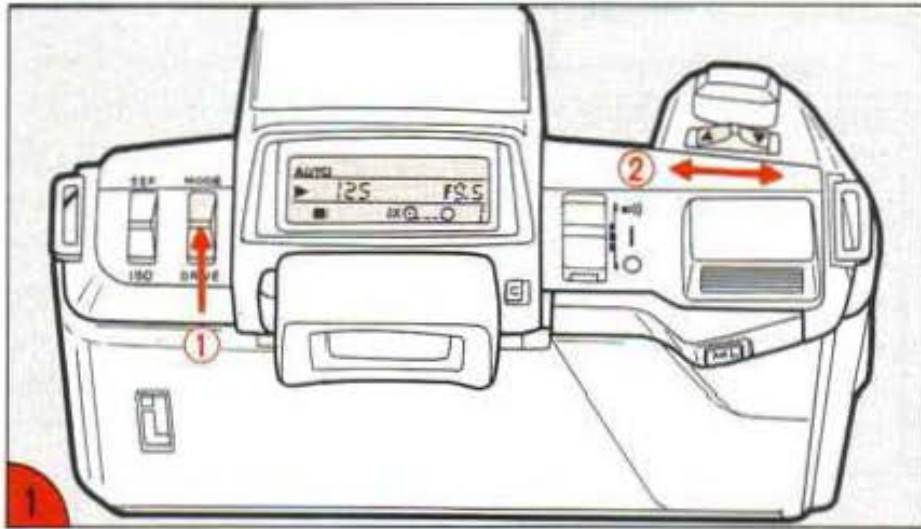

### Shutter-Priority AE Mode

Once the desired shutter speed is set, the camera automatically selects an appropriate aperture according to the lighting conditions surrounding the subject for a perfect exposure. Use this mode to capture a fast-moving subject (as in sports) as well as for taking ordinary snapshots.

1. When you select the Shutter-Priority AE mode, the CENTIC panel confirms it by displaying [AUTO], [▲] and the shutter speed selected. If any other indicator on the panel lights up, use the mode/drive switch and the select switch to set this mode.

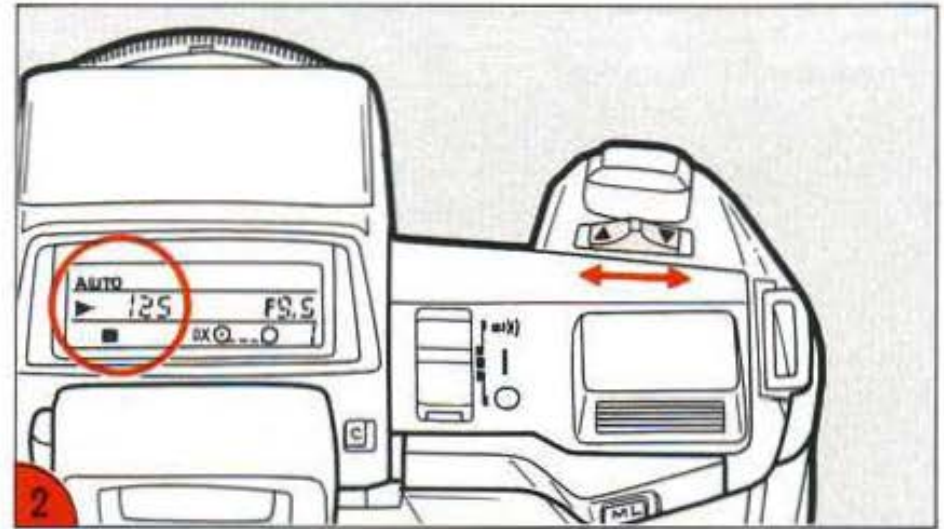

2. To select a faster shutter speed, slide the select switch to the UP position. Slide it to the DOWN position to select a slower shutter speed. One push moves the shutter speed to the next setting, and the speed is shifted continuously if the select switch is held at one position.

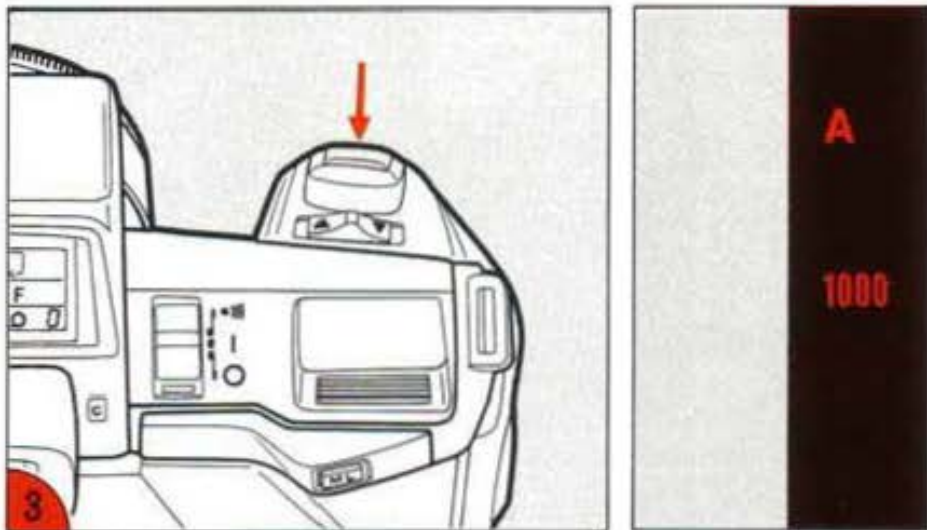

- When you press the shutter release button halfway down, "A" and a selected shutter speed will appear in the viewfinder, while the CENTIC panel indicates the aperture suitable for the selected shutter speed.

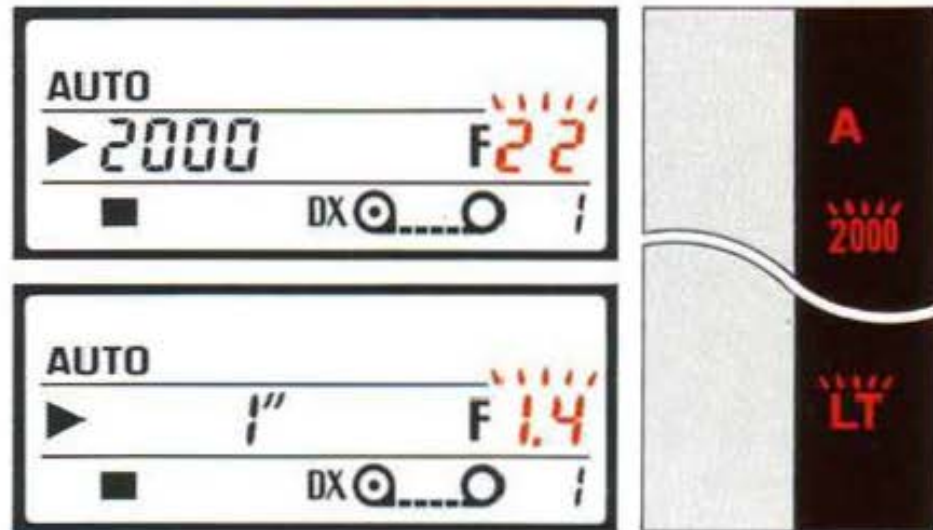

### Shutter-Priority AE Mode Warnings

When the subject is too bright or too dark, the viewfinder and CENTIC indicators blink to warn you. If this occurs, shift the shutter speed either to a faster setting (toward "2000") or to a slower one (toward "LT") until the indicators stop blinking. When selecting a shutter speed of 1/30 second or slower (shown by the orange indicators in the viewfinder), the use of a flash or tripod is recommended to avoid camera shake. (See page 26 for more detailed information on warnings.)



### Exposure Modes When Aperture Ring is Set at an F-Number

- Aperture-Priority AE mode
- Metered Manual mode
- 100 (fixed at 1/100 sec.)
- Bulb

- See page 52 for detailed information on "100" and "bulb" settings.
- The exposure modes mentioned above can be used in combination with SMC Pentax-F, -A, -M and SMC Pentax lenses.

### Aperture-Priority AE Mode

Once the desired aperture is set, the camera automatically selects an appropriate shutter speed according to the lighting conditions surrounding the subject for the best possible exposure. Use this mode for photographing subjects in which the depth of field is crucial, such as close-ups, landscapes and portraits.

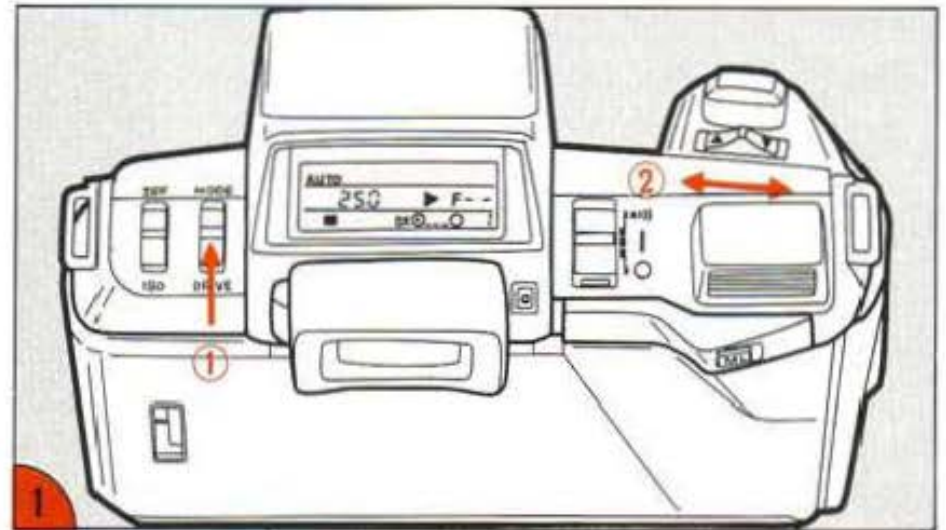

1. When you select the Aperture-Priority AE mode, the CENTIC panel confirms it by activating its [AUTO], [▲] and [F--] indicators. If the camera is set at any other mode, use the mode/drive switch and the select switch to set this mode.

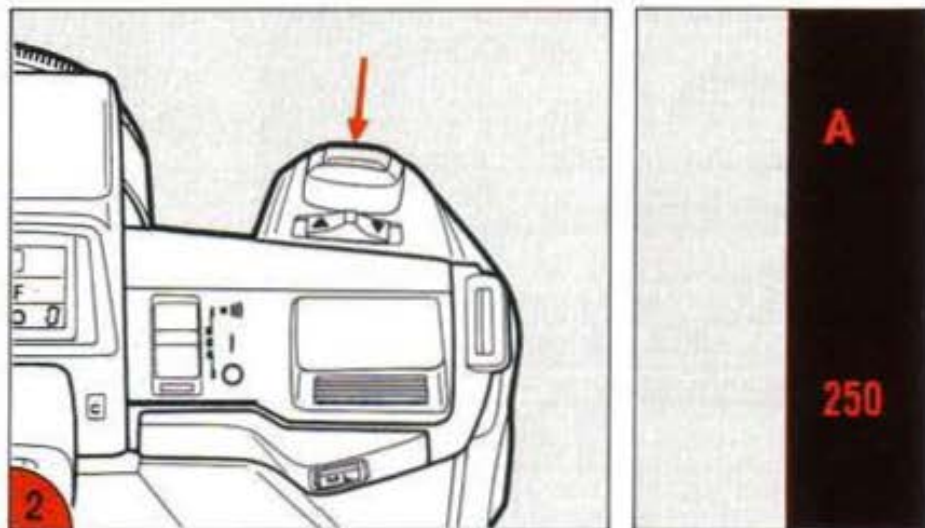

2. When you press the shutter release button halfway down, "A" and a shutter speed will appear in the viewfinder, while the CENTIC panel indicates the shutter speed.

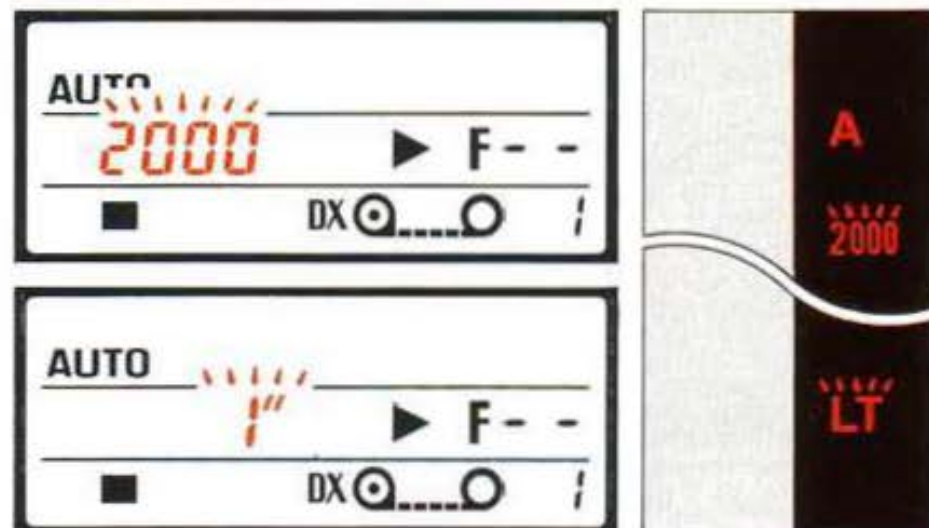

#### Aperture-Priority AE Mode Warnings

When the subject is too bright or too dark, the viewfinder and CENTIC indicators blink to warn you. Turn the aperture ring either to a smaller f-number (toward f/1.4, etc.) or to a larger one (toward f/22, etc.) until the indicators stop blinking. When the selected shutter speed is 1/30 second or slower (shown by orange indicators in the viewfinder), the use of a flash or tripod is recommended to avoid camera shake. (See page 26 for more detailed information on warnings.)



## SHOOTING IN THE METERED MANUAL MODE



### Metered Manual Mode

To obtain the correct exposure in this mode, set a shutter speed and an aperture according to the exposure meter's reading. It is also possible to intentionally over- or underexpose the subject for a special visual effect or a photographic theme.

When the Metered Manual mode is selected, the CENTIC panel confirms it by activating its [MAN.], [▶] shutter speed and [▶] aperture indicators. If the camera is set at any other mode, use the mode/drive and select switches to set this mode.

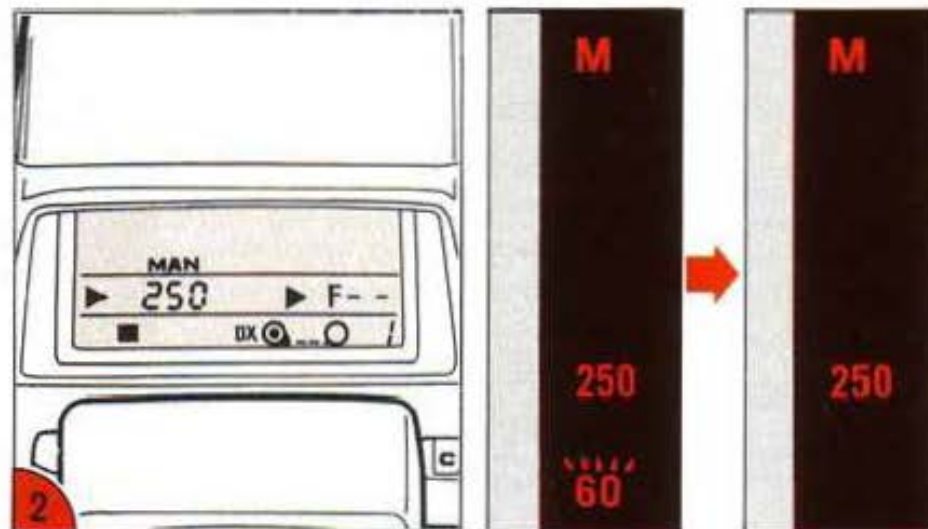

1. When you press the shutter release button halfway down, the viewfinder displays "M" and a shutter speed. If, as illustrated above, two indicators — one solidly lit and another blinking — appear at the same time, it indicates an incorrect exposure. If this occurs, adjust either the shutter speed or the aperture so that only one solidly lit indicator remains. This indicates that the exposure is correct.
2. **To determine the shutter speed first**  
Turn the lens aperture ring one way or the other until only one solidly lit indicator remains in the viewfinder. If the correct exposure cannot be obtained this way, reset the shutter speed.

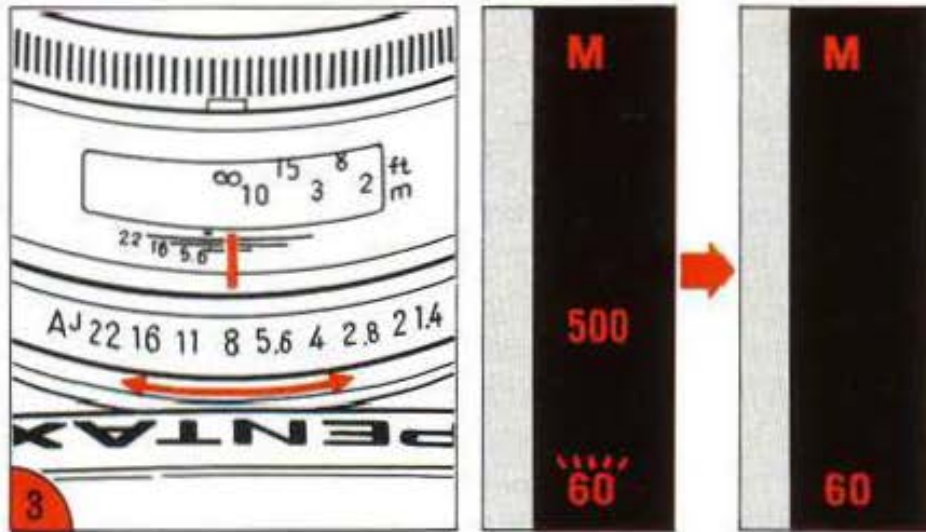

### 3. To determine the aperture first

Slide the select switch to the UP or DOWN position until only one solidly lit indicator remains in the viewfinder. If the correct exposure cannot be obtained in this way, reset the aperture.

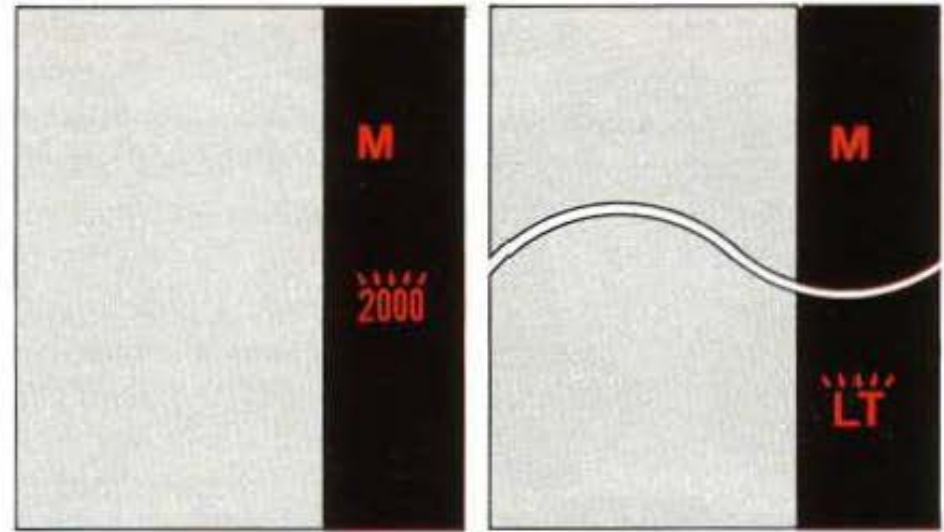

### Metered Manual Mode Warnings

When the subject is too bright or too dark, the viewfinder indicators blink to warn you. Turn the aperture ring either to a smaller f-number (toward f/1.4, etc.) or to a larger f-number (toward f/22, etc.) until the indicators stop blinking. When the selected shutter speed is 1/30 second or slower (shown by the orange indicators in the viewfinder, the use of a flash or tripod is recommended to avoid camera shake. (See page 26 for more detailed information on warnings.)



# CENTIC PANEL AND VIEW FINDER WARNINGS

Viewfinder	CENTIC	Remarks
P 2000	2000 F 22	The subject is out of the metering range of the Programmed AE modes. The correct exposure cannot be obtained using the current settings.
P LT	1" F1.4	
A 2000	F 22	The subject is out of the shutter-speed/aperture coupling range or the metering range in the Shutter-Priority AE mode. The correct exposure cannot be obtained using the current settings. In the former case, change the shutter speed to obtain the correct exposure. In the latter case, the indicators will keep blinking even if the shutter speed is changed.
A LT	F1.4	
A 2000	2000	The subject is out of the shutter-speed/aperture coupling range or the metering range in the Aperture-Priority AE mode. The correct exposure cannot be obtained using the current settings. In the former case, change the aperture to obtain the correct exposure. In the latter case, the indicators will keep blinking even if the aperture is changed.
A LT	30"	
M 500 125		The subject is out of the Metered Manual mode's correct exposure range. Change the shutter speed and/or the aperture until only one solidly lit indicator remains; this indicates correct exposure is possible.
M 250 60		
M 2000		The subject is out of the Metered Manual mode's metering range. The indicators will keep blinking even if the shutter speed and/or the aperture are changed. The correct exposure cannot be obtained using the current settings.
M LT		
P 250		When the exposure memory lock is in use, the viewfinder indicators blink to confirm it.
P 60		The low battery level is warned by blinking indications.

- All warnings are given by blinking the indicators on the CENTIC panel and in the viewfinder.
- The out-of-metering range warning means the subjects is too bright or too dark to be measured with the camera's built-in exposure meter.
- The out-of-coupling range warning means the current combination of shutter speed and aperture cannot be used even if it is within the metering range.
- See page 38 for the metering and coupling ranges.
- The symbol [ ∙∙∙∙ ] in the table at left indicates blinking.

### How to photograph a subject in the out-of-metering range

- If the subject is too bright, use ND filters (available commercially).
- If the subject is too dark, you will have to use a flash or other lighting equipment.



## EYECUP F AND DIOPTRER ADJUSTMENT

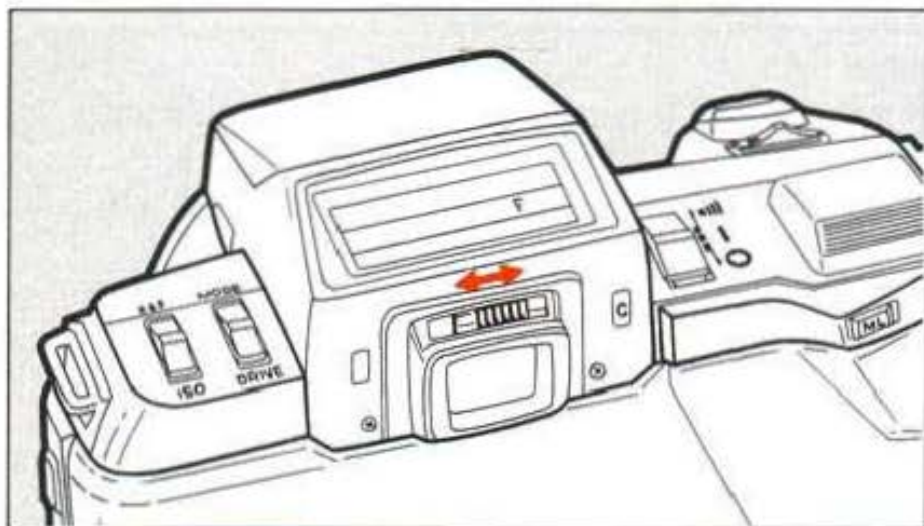

### **Eyecup F**

The Eyecup F is attached to the viewfinder accessory groove.

To use the diopter adjustment slide or attach the viewfinder cap (standard) and an optional viewfinder accessory such as the Magnifier F, remove the Eyecup F by pushing up its sides as in the illustration.

- The Eyecup F cannot be used in combination with an optional viewfinder accessory such as a diopter correction lens.

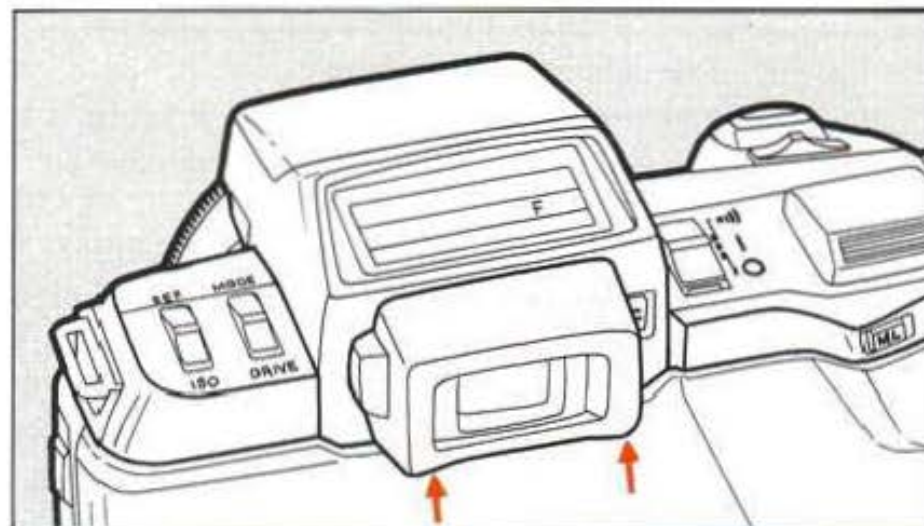

### **Diopter Adjustment Mechanism**

Unless the diopter is correctly adjusted, the viewfinder image cannot be viewed clearly. Adjust the diopter to your eyesight before using the camera.

To adjust the diopter, point the camera to a bright area without focusing. Move the diopter adjustment slide sideways until you can find a point where the focus frame at the center of the viewfinder can be seen most clearly. The diopter adjustment range is between  $-1.5$  and  $+1.5$  diopters.

- SMC Diopter Correction Lenses-M are also available as options.

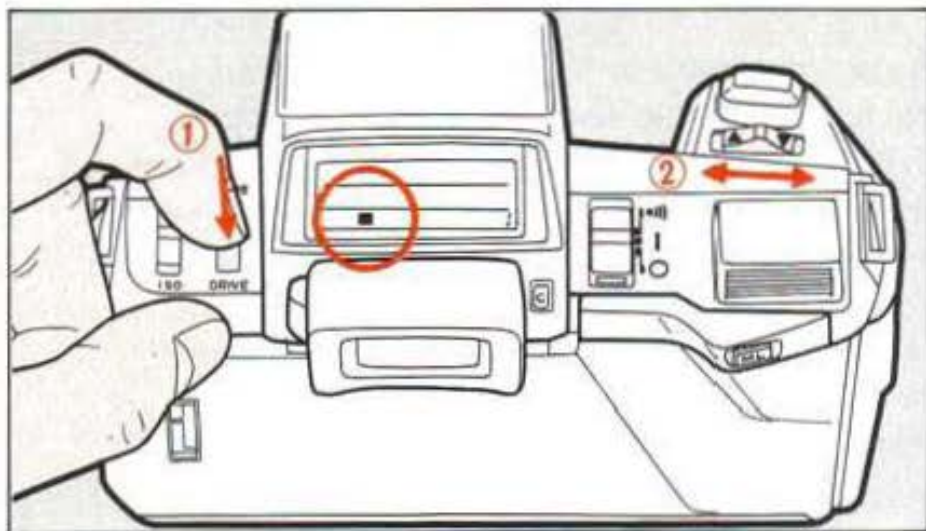

## Drive Modes

To set a drive mode, slide the select switch to the UP or DOWN position while pressing the mode/drive switch to the DRIVE position until the mark representing the desired mode appears on the CENTIC panel. If the select switch is held at one position, the marks will change continuously.

[🕒] = **Self-timer mark** (see page 49.)

[■] = **Single advance**

When you press the shutter release button, the motor drive advances the film to the next frame and stops.

[🔥] = **Consecutive advance**

As long as you hold the shutter release button down, the motor drive keeps advancing the film at a speed of approx. 1.8 frames per second.

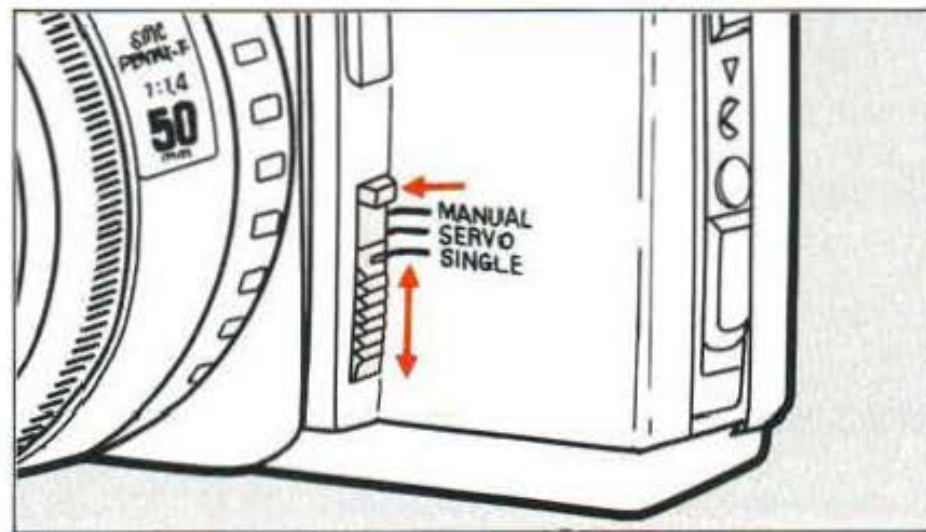

## Focusing Modes

### Auto-Focus (AF) Modes

#### ① AF SINGLE

Focusing continues until the subject is captured in focus. The shutter can then be released.

#### ② AF SERVO

If the subject moves, the camera continues focusing on it. The shutter can be released anytime, even if the subject is not in focus.

### Manual Focus Mode

#### ③ MANUAL



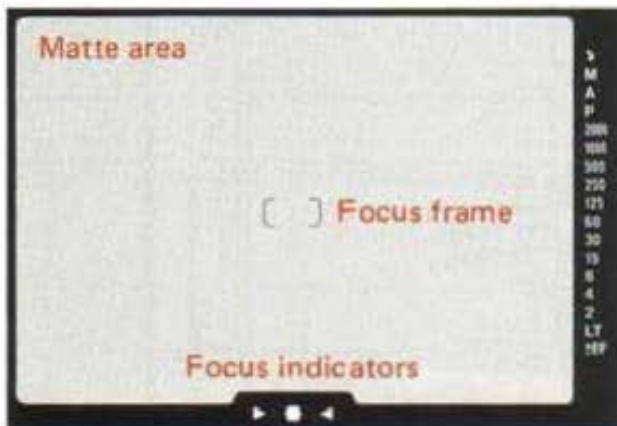

Push up the focus-mode switch while pressing the manual-focus button. Focusing can be done manually with the assistance of the FI (Focus Indication) system.





## Auto-Focus Modes (AF SINGLE and AF SERVO)

- Position the subject at the focus frame at the viewfinder's center.
- Press the shutter release button halfway down. If the green in-focus indicator at the bottom of the viewfinder lights up, the subject is in focus and you can release the shutter. When the main switch is set at the [•] position, the correct focus is also confirmed by a PCV tone.
- With F-series zoom lenses, the image size can be adjusted by turning the zooming ring of the lens.
- Do not touch or impede the focusing ring of the lens as it rotates during auto focusing.

FI Indicator	Remarks
 (Solid green signal)	The in-focus signal: The subject is in focus and the picture can be taken.
 (Blinking red signals)	Out-of-focusing range warning: You can focus by pointing the camera at a brighter area of the subject. If it still will not focus, see page 33 on "Difficult Subjects for auto focusing." In dark locations, the use of a flash is recommended.
 (Solid red signal)	The subject is too close for auto focusing, so move back.
 (Blinking red signals)	The macro setting of the F-series zoom lens is being used. [▶] = Out of focus because the subject is too close, so move back. [◀] = Out of focus because the subject is too far away, so move forward.

### AF SINGLE Mode

- The shutter cannot be released until the subject is in focus.
- Focusing is fixed as long as you press the shutter release button halfway down with the green in-focus signal [○] on. (See page 32 about the focus-lock function.) To change the direction of shooting after focusing is fixed, it is necessary to let the shutter release button go and press it again.
- If you press the shutter release button all the way down in one movement, the shutter is released after the subject is in focus.
- The “Snap-in-Focus” can be used in combination with a Pentax K<sub>A</sub>- or K-mount lens. Adjust the focus manually at the point you expect to capture the subject and hold the shutter release button all the way down. The shutter will release automatically as soon as the subject moves into the prefocused area.

### AF SERVO Mode

- In the AF SERVO mode, you can release the shutter anytime, regardless of the focusing situation. As long as you press the shutter release button halfway down, the camera continues focusing on the subject even when it is moving.
- If you release the shutter when the green in-focus signal [○] lights up, the subject is captured in focus.

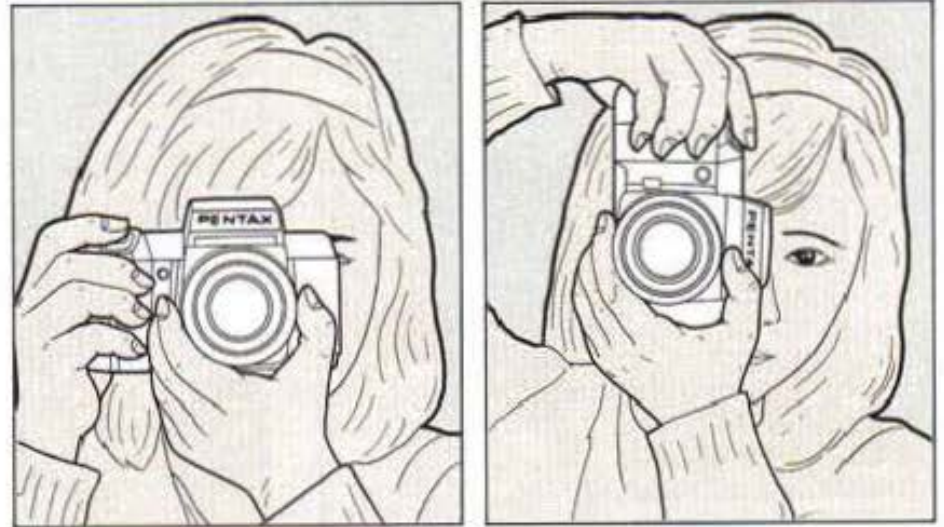

### How to Hold the Camera

To take sharply focused pictures, it is essential to hold the camera properly. The shutter release button should be pressed softly while you hold your breath, since a sudden, rough release can cause camera shake and produce blurred images. Brace the camera and your body on a tree, building or table. When using a slow shutter speed or a telephone lens, the use of a tripod and the Cable Switch F is recommended.



## FOCUS LOCK



### Be careful!

If the shutter is released at this moment, the subjects will be out of focus. The background will be in focus instead.

If the subject is not positioned in the focus frame [ [ ] ] at the center of the viewfinder, use the focus lock by following the procedures described at right. The focus lock can be used only in the AF SINGLE mode.

1. Position the subject in the focus frame at the center of the viewfinder and press the shutter release button halfway down. The green in-focus signal [ ] and the PCV tone confirm that the subject is in focus.
  2. While you hold the shutter release button halfway down, recompose the image to your liking and release the shutter.
- As long as you hold the shutter release button halfway down and the green in-focus signal is on, the focus remains locked. When you remove your finger, it is unlocked. This procedure can be repeated any number of times.

### Difficult Subjects for Auto Focusing

This camera's auto-focusing system is extremely precise and highly sophisticated, yet there are certain types of subjects (due to their brightness, contrast, shape and size) that make focusing very difficult. For these situations, use the focus lock or manual focusing, or take advantage of the built-in RTF (Retractable TTL-Auto Flash) in dark locations.

- Extremely low-contrast subjects (little difference between the bright and dark areas), such as a white wall.
- Extremely dark subjects.
- Extremely fast-moving subjects.
- Subjects with only horizontal lines.
- Subjects with detailed and/or complex patterns.
- Subjects positioned against harsh reflected light, strong backlight or an extremely bright background.
- Subjects composed of elements both near and far within the focus frame.

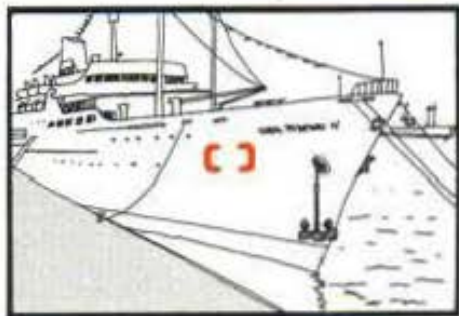

### Accessories Not Usable in Auto Focusing

The following accessories cannot be used in the auto-focus mode or the FI (Focus Indication) system. Use the matte area of the viewfinder for focusing.

- Special-effect filters, magic-image attachments or stereo adapters.
- Linear polarizing filters because this camera has a half-mirror. Use the circular polarizing filters.
- Extension Tubes and Auto Bellows.



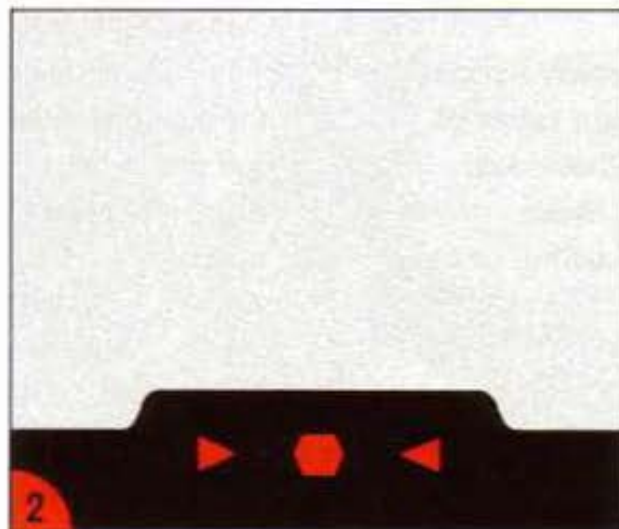
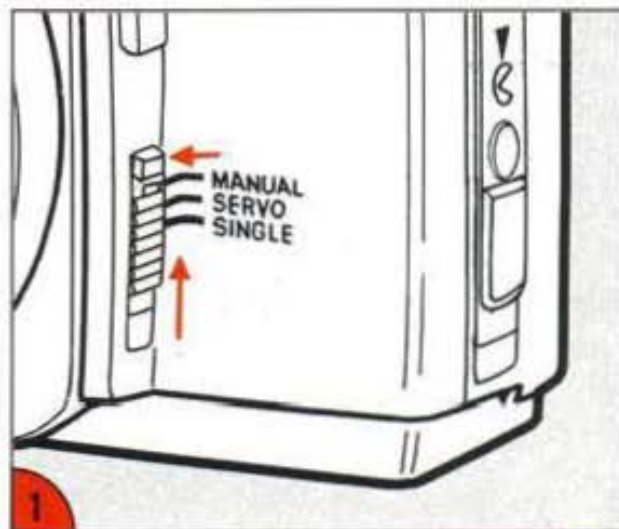

When using existing Pentax A- and M-series lenses, focusing needs to be done manually with the assistance of the FI (Focus Indication) system. The same operations can be applied to the F-series lenses if the auto-focus system is not used.

### Usable SMC Pentax Lenses

The following lenses with a maximum aperture of f/5.6 or larger can be used:

- F-series (KAF mount) and A-series (KA mount) lenses,
- M-series and Pentax lenses (K mount).

1. Set the focus-mode switch to the MANUAL position.
2. As illustrated, one or more of the FI signals light up when you press the shutter release button halfway down.
3. Turn the lens focusing ring to the right for the [▶] signal and to the left for the [◀] signal. If the green in-focus signal [□] lights up, the subject is in focus. When the main switch is set at the [•] position, the correct focus is also confirmed by a PCV tone.

### FI Signal

- [▶] = Front-focus signal: Turn the focusing ring to right.
- [◀] = Back-focus signal: Turn the focusing ring to left.
- [○] = In-focus signal: The subject is in focus.
- ▶ ◀ = Out-of focus-range warning: Unable to focus.

Only lenses with a maximum aperture of f/5.6 or larger can be used in the FI system. The FI signals may appear in the viewfinder even when some other slower lens (such as 1000mm f/8) is mounted for high-contrast subjects, but the accuracy is not at the optimum level. For such lenses, use the matte area of the viewfinder for focusing.

\* SMC Pentax Bellows 100mm f/4, SMC Pentax Shift 28mm f/3.5 (when shifted) and reflex-type lenses cannot be used in the FI system. Use the matte area of the viewfinder for focusing.

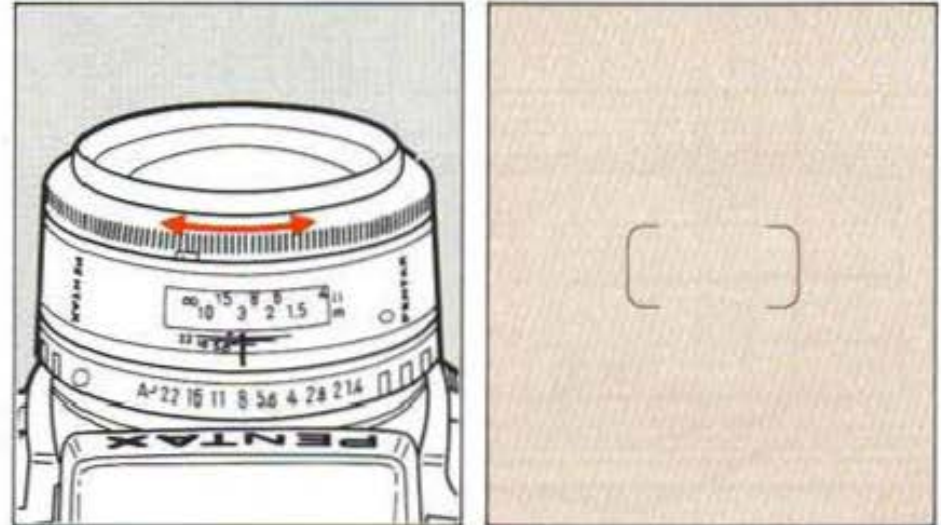

### Focusing Using the Viewfinder Matte Area

For subjects that are difficult to focus on automatically or measure the distance to, and when using an old Takumar-series lens with the Mount Adapter K (optional), use the matte area of the viewfinder for manual focusing.

- Set the focus-mode switch at the MANUAL position.
- Turn the lens focusing ring to the point where the subject appears most clearly, then release the shutter.



## UNLOADING FILM (Be sure to remove the film from the camera in the shade.)

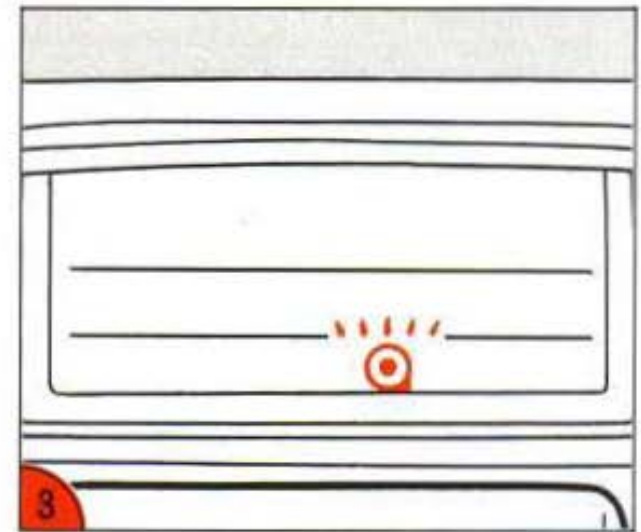
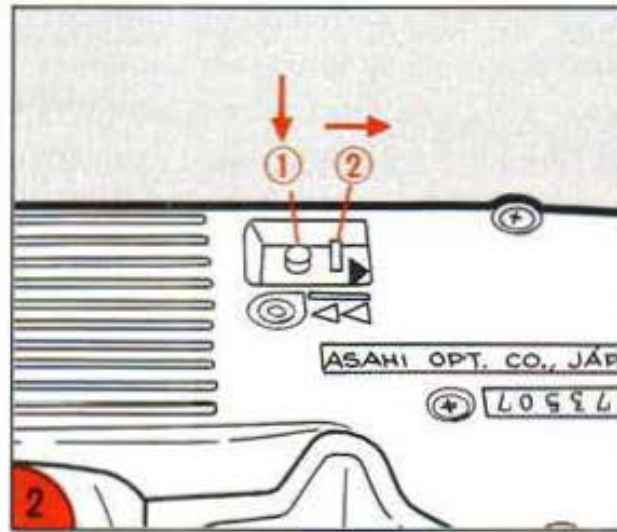
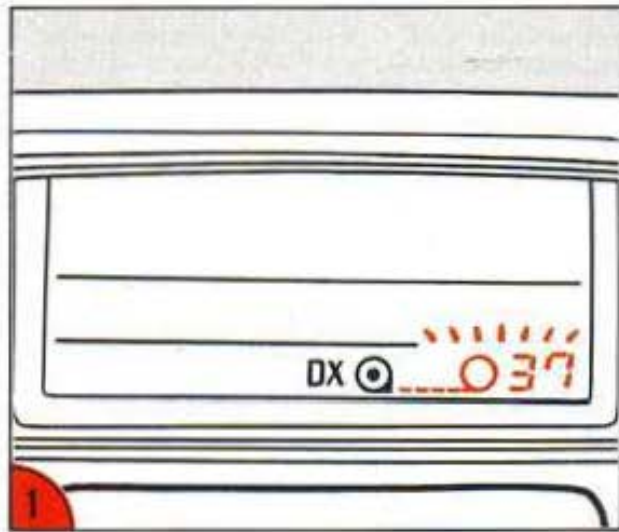

When the film reaches its end, the motor drive automatically stops winding. However, do not open the camera's back cover immediately. The exposed film must be returned to its cartridge before removing it from the camera.

1. When the film reaches its end, the film-advance and end-of-film marks as well as the exposure frame counter will blink to inform you of the fact.

2. Slide the rewind switch **2** at the bottom of the camera toward the direction of an arrow while depressing the rewind button **1**. The camera's motor will start rewinding the film. Remove your finger once the motor is activated.
3. During rewinding, the film-advance mark flashes from left to right. When rewinding is completed, the shutter is released once and the motor stops. The film-loaded mark then blinks to inform you that the rewind operation is finished.

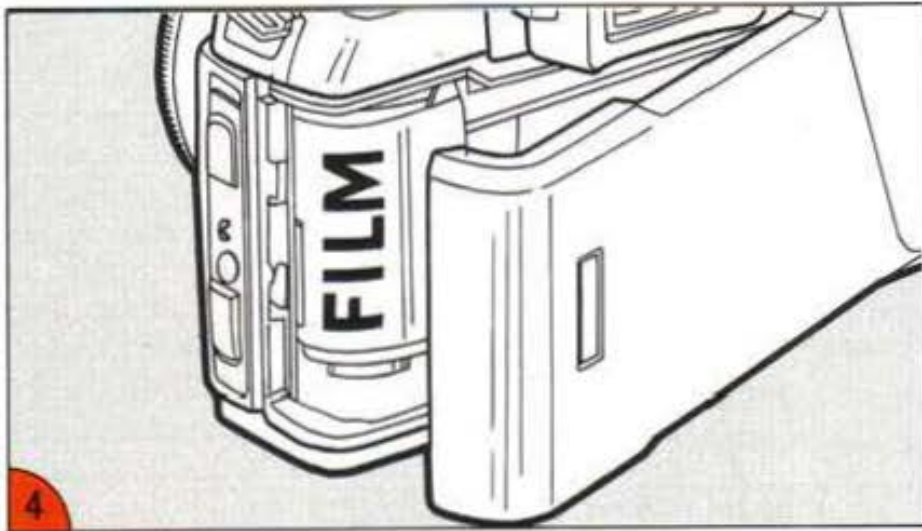

4. Open the back cover and remove the film by pulling out the bottom of the film cartridge with your finger.

- Rewind time is approximately 20 seconds for a 24-exposure roll of film.
- Open the back cover only after confirming completion of the rewind operation by the blinking film-loaded mark.
- If the film is exposed for a greater number of frames than designated on the film cartridge, the extra frames may be cut off at the developing laboratory.





# PROGRAMMED AE DIAGRAM AND METERING RANGE

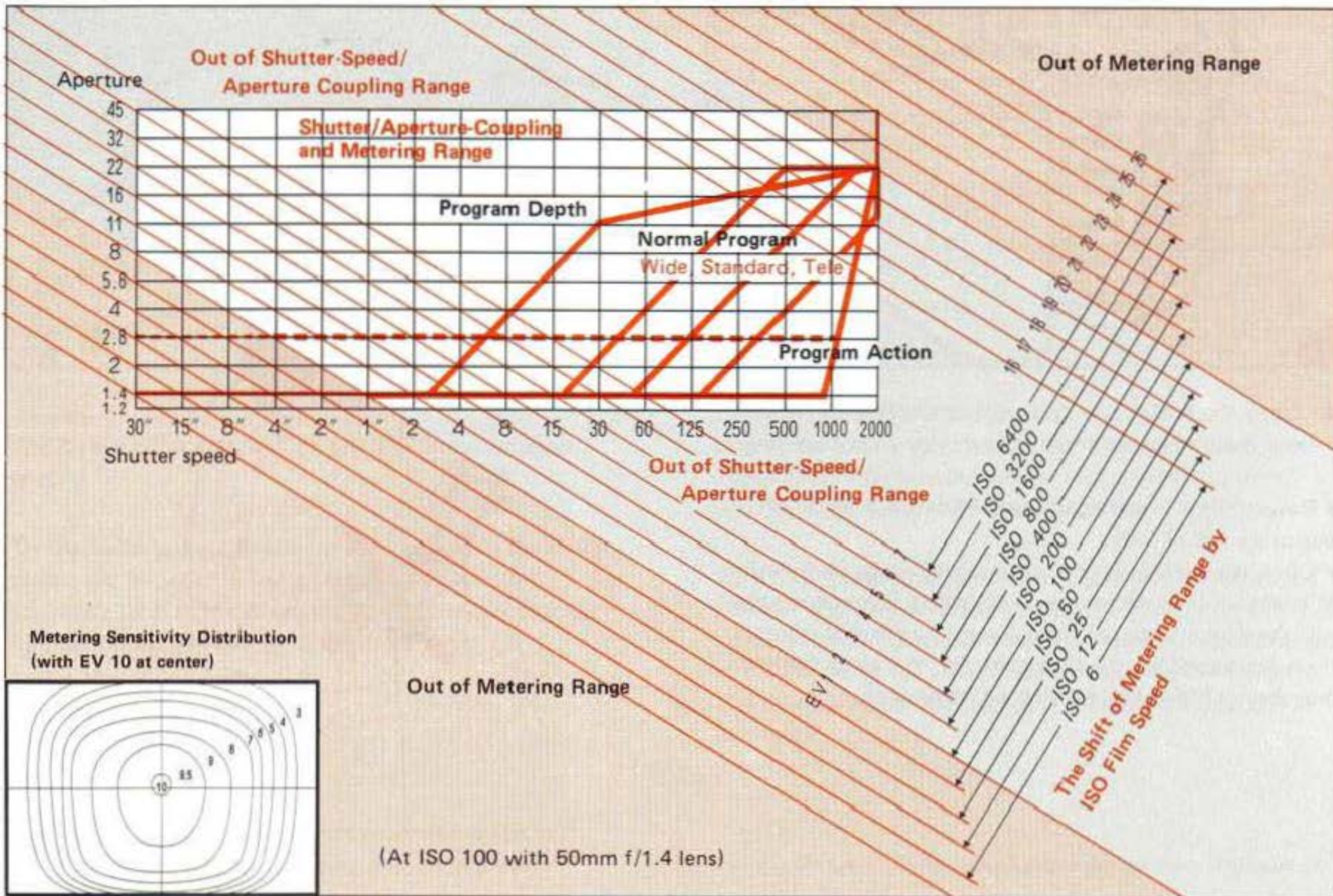



### **Programmed AE Diagram**

This camera has three Programmed AE modes — Normal Program, Program Action and Program Depth. The thick solid lines of the diagram at left represent the shift in the combination of shutter speeds and apertures. This combination can be shifted up to the maximum aperture of the lens in use: the combination of an f/2.8 lens is indicated by a red dotted line as an example.

In the Normal Program mode, the combination is automatically shifted to a program for one of three sub-modes — Wide, Standard and Tele — depending on the lens in use.

The Program Action mode is programmed to select a high shutter speed.

The Program Depth mode is programmed to increase the depth of field by selecting a small aperture.

The thin solid lines and thin dotted lines on both sides of the diagram indicate different coupling ranges when lenses with different maximum and minimum apertures are used, or when the ISO film speed is changed. As the aperture range of the lens (f/1.4 — f/22) changes, the limits of the metering range change as well.

### **Metering Range and Shutter-Speed/Aperture Coupling Range**

Metering range refers to the range of subject illumination within which the built-in exposure meter can operate to control an exposure. The shutter-speed/aperture coupling range is a part of the metering range within which possible combinations of shutter-speed and aperture values for proper exposure control can be found. For example, the metering range for a 50mm f/1.4 standard lens with ISO 100 film is from EV 1 (f/1.4, 1 sec.) to EV 20 (f/22, 1/2000 sec.).

As the ISO film speed changes, the metering range changes as well. The thin slanted red lines in the diagram at left indicate the change in metering ranges in relation to ISO film speed. The inside of the center frame represents the meter and shutter-speed/aperture coupling range.

### **EV (Exposure Value)**

EV represents the brightness of the subject and is indicated by a number.



## USING A BUILT-IN FLASH (RTF)

This camera is equipped with a built-in Retractable TTL-Auto Flash (RTF) unit. The RTF is ideal for use in dark locations where the auto-focus system does not work, and for flash photography. Even when photographing a person under the shade of a tree or in a dark location during the daytime, the RTF can be used as a fill-in flash in the Programmed AE mode for daylight flash-sync photography.

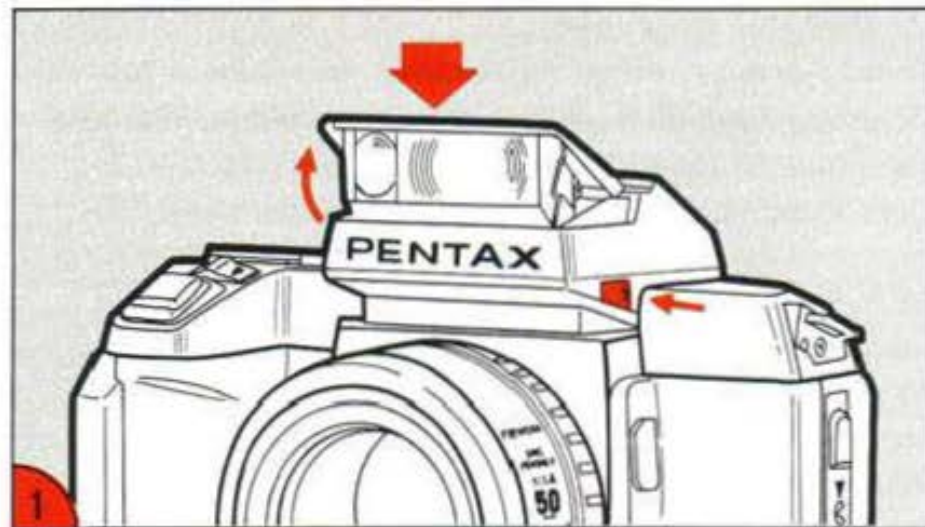

1. When the flash pop-up button is pushed, the RTF swings up and forward and starts charging. After use, push it back down into the housing.

- **Guide Number:** 14 (ISO 100/m)
- **Usable Lenses:** 35mm to 210mm (excluding Macro 100mm)
- **Recycle Time:** Approximately 3 seconds (using a 6V lithium battery)
- **Effective Flash Range:** Approximately 1m to 5m (ISO 100, f/2.8)
- **Usable Films:** ISO 25 to 400

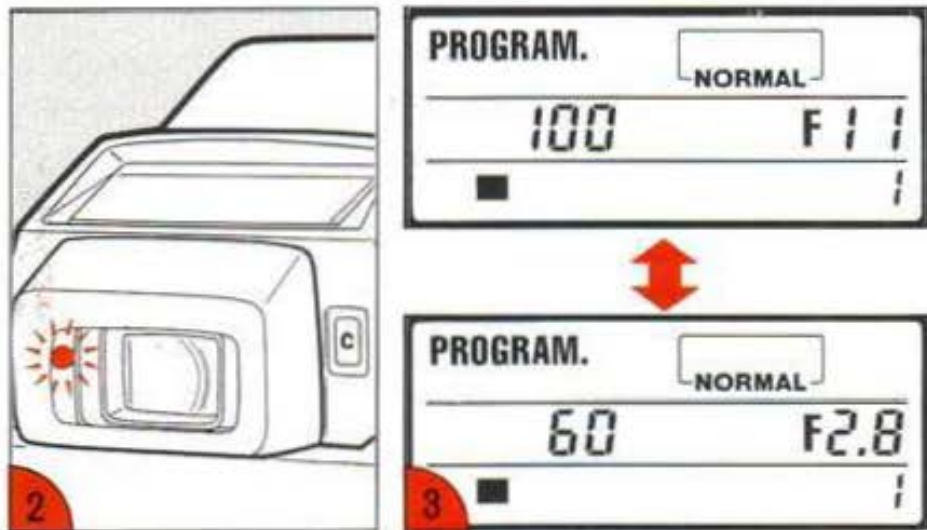

2. When the RTF is fully charged, the red flash-ready indicator next to the viewfinder eyepiece (inside Eyecup F) lights up to confirm it.
3. If the lens aperture ring is set at the "A" position for the selected exposure mode (e.g. the Programmed AE modes), the flash-sync shutter speed (1/60 sec.~1/100 sec.) and the aperture (f/2.8~f/11 at ISO 100) are automatically changed according to the brightness of the subject, making the daylight flash-sync photography extremely simple.

The flash-sync shutter speed and the aperture are displayed on the CENTIC panel when the shutter release button is depressed halfway down. In the viewfinder, the exposure mode ["P" or "A"] and the sync speed ["60"] are indicated, but the flash-ready indicator [☀] is not.

**Effective Flash Ranges of the Program Flash System**

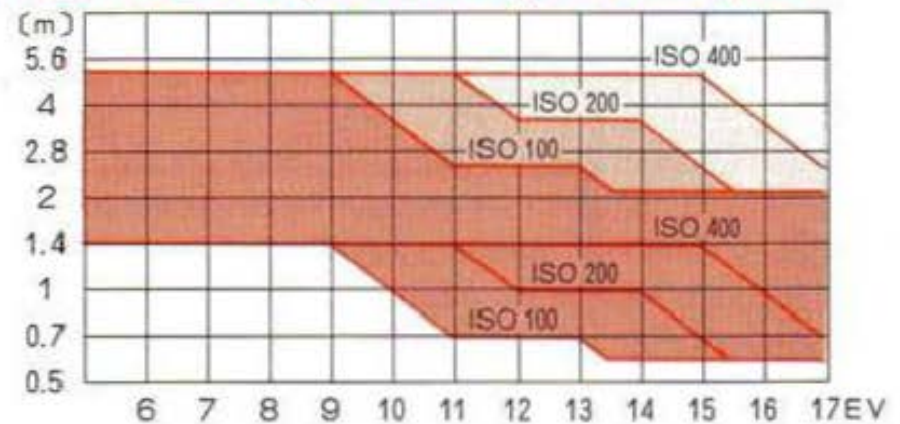

The chart above shows the RTF's effective flash ranges in the Program Flash system for lenses with a maximum aperture of f/2.8 or larger. For lenses with a smaller maximum aperture (f/4, for example), the range is extended another block at the bottom (from 1.4m to 1m, for example).



- If the lens aperture ring is set at any f-number for the selected exposure mode, the effective flash range is determined by the selected aperture ( $G.N. 14 \div f/4 = 3.5m$ ), and the flash-sync shutter speed is set at 1/100 sec.
- When a lens with a maximum aperture of f/2.8 or smaller is used, the aperture display in the CENTIC panel starts from that maximum aperture of the lens.
- The Program Flash system can be used in combination with a Pentax-F or -A lens. Be aware that the RTF's discharge may be cut off by wide-angle lenses or lenses with a large diameter.
- When a Pentax-F lens that may cut off the RTF's discharge is mounted (e.g., some zoom, telephoto and macro lenses), the red flash-ready indicator [  ] blinks to warn the photographer. In this case, the shutter can be released but the RTF will not discharge.
- Do not use a lens hood. The RTF's discharge is also cut off within the distance of 1m when a 35mm wide angle is mounted, so do not use the RTF in such cases.
- Be aware that photographing a person straight on from the front using a flash beyond a distance of 3m may cause the "red-eye" phenomenon produced when light reflects off the retinas. (This can be avoided by directing the subject's gaze away from the camera.)

### AF Spotbeam Projector

When using the RTF in a dark location, the AF spotbeam projector automatically emits an infrared beam to assist the auto-focus system.

The spotbeam projector can also be used in dim locations where the auto-focus system may not work effectively.

- The AF spotbeam projector can be used only when the focus-mode switch is set at the SINGLE position. It will not work at any other position.
- The AF spotbeam projector's effective range is approximately 1m to 4m. If flash illumination is unnecessary, push down the RTF unit after the AF system captures the subject in focus.
- The AF spotbeam projector does not operate for bright subjects.
- If the [  ] indication appears, auto-focusing is impossible. (See pages 33 to 35.)
- When the AF400FTZ's AF spotbeam projector is used, the AF spotbeam projector built into the camera does not operate.







## USING PENTAX DEDICATED FLASH UNITS

If the camera is set in an AE (automatic exposure) mode or the Metered Manual mode, a Pentax dedicated auto flash unit can be used anytime.

### How to Use an Accessory Flash

1. Remove the camera's hot-shoe cover and attach the flash unit.
2. Set the flash mode to TTL Auto or Programmed Auto.
3. Turn the flash's main switch on.
4. The completion of the flash-charging operation can be confirmed by checking the flash unit's flash-ready indicator, as well as the flash-ready indicator [  ] in the viewfinder and the flash-sync speed display on the CENTIC panel, both of which are turned on when the shutter release button is pressed halfway down. (The indications for the RTF are slightly different.)
  - When the exposure meter's timer goes off, the [  ] and flash-sync shutter speed indicators also switch off.
  - For this camera, please take advantage of the new AF400FTZ dedicated auto zoom flash, which possesses the many capabilities shown at right.



### Functions of RTF and Dedicated Auto Flash Units

- When using an old-type flash unit (AF160S or AF200S), use the lens aperture ring to select the desired f-number.
- \* The red flash-ready indicator located to the left of the viewfinder eyepiece lights up when the flash is fully charged.
- The flash unit may not discharge if the subject is too bright to require a flash.
- ☆ AF200SA, AF240Z and AF160SA apply.

### TTL Auto Flash System

When you attach a Pentax dedicated TTL auto flash unit, the camera's metering circuits automatically control the flash output for a proper exposure by measuring the incoming light reflected off the film plane. Since this system measures only the light reflected by the subject, it ensures accurate exposure control.

## Functions of RTF and Dedicated Auto Flash Units

Camera's Functions	RTF	AF400FTZ	AF400T AF280T AF200T AF080C	AF200SA AF240Z AF160SA AF200S AF160S
When flash charging is completed and the shutter release button is depressed halfway down, the flash-ready indicator [  ] appears in the viewfinder, and the shutter speed "100" (1/100 sec.) appears on the CENTIC panel. When using the older models such as the AF160S and AF200S, set an f-number using the lens aperture ring.	○* (60-100)	○ (60-100)	○ (100)	○ (100)
With the lens aperture ring locked at the "A" position, the appropriate aperture value is set automatically.	○	○	○	☆
Successful flash discharge is confirmed by the flash-ready indicator [  ] in the viewfinder, which either turns off briefly and back on again or blinks after exposure.		○	○	
Flash output is automatically controlled by measuring the amount of light striking the film plane during exposure. (TTL Auto Flash)	○	○	○	
Slow shutter-speed sync operation under 1/100 second is possible in the Metered Manual mode.	○	○	○	○
Built-in AF spotbeam projector for assisting auto focusing in dark locations.	○	○		
Selection of the leading shutter-curtain or trailing shutter-curtain sync mode.		○		



# TTL AUTO FLASH AND PROGRAMMED AUTO FLASH MODES

## TTL Auto Flash Mode

### For Programmed AE and Shutter-Priority AE Modes

- Like the built-in RTF unit, the AF400FTZ, which is designed exclusively for use with this camera, automatically adjusts the shutter speed and aperture according to the subject's brightness, making it easy to accomplish even complicated daylight flash synchronization. (See the operating manual of the AF400FTZ for more detailed information.)

- With a conventional dedicated flash unit (AF400T, AF280T, AF200T and AF080C), a flash-sync speed of 1/100 second and an aperture of f/4 (f/8 for AF080C) are set as soon as the flash is fully charged (at ISO 100). However, these units are not recommended for daylight flash sync photography.

\* With zoom lens whose maximum aperture changes (from f/3.5 to f/4.5, for example) according to the focal length, the f-number indication (e.g. f/4, ISO 100) may start blinking to indicate that exposure is out of the coupling range, depending on the focal length selected. Be aware that this might result in underexposed images with the current settings.

### For Aperture-Priority AE and Metered Manual modes

- Select the desired f-number using the lens aperture ring.
- The flash-sync speed of 1/100 second is set as soon as the flash is fully charged.

## Programmed Auto Flash Mode

### For Programmed AE and Shutter-Priority AE Modes

- Set the flash's mode switch at one of the AUTO (red, green or yellow) positions for dedicated flash units such as the AF400T, AF280T, AF200T and AF200SA.
- A combination of a flash-sync speed of 1/100 second and a lens aperture is selected as soon as the flash is fully charged, as indicated in the chart below.

(at ISO 100)

	AF400T	AF280T	AF200T
Red	f/4	f/4	f/2.8
Green	f/8	f/8	f/5.6
Yellow	f/11	—	—

(AF200SA: f/4 at ISO 100)

### For Aperture-Priority AE and Metered Manual Modes

- Set the flash's mode switch at one of the AUTO (red, green or yellow) positions.
- Set the same f-number on the lens as the one indicated by the flash's exposure scale.
- The flash-sync speed of 1/100 second is set as soon as the flash is fully charged.

### Common Functions of TTL Auto Flash and Programmed Auto Flash Modes

In the Metered Manual mode, slow-shutter-speed synchronization can be used by selecting a shutter speed between 1/60 second and one second. The shutter speed can be selected by sliding the select switch to the UP or DOWN position until the desired speed appears on the CENTIC panel.

- When the shutter speed is set between 1/2000 second and 1/125 second, it is switched to the flash-sync speed of 1/100 second when the flash is fully charged.

### Flash Confirmation Signal ( )

When a proper flash exposure is made in the TTL Auto Flash or Programmed Auto Flash mode while the camera is set in an AE or Metered Manual mode, the flash-ready indicator [  ] in the viewfinder confirms it right after the discharge, either by disappearing for a moment and coming back on again or by blinking.

\* The AF200SA does not have the flash confirmation signal function.

### Precautions for Using Pentax Dedicated Flash Units

- When using a flash unit in the manual sync (MS) or manual (M) mode, select an f-number using the lens aperture ring. If the ring is set at the "A" position, a correct exposure cannot be made. The functions in the MS and M modes may vary depending on the type of flash used, so check the operating manual of the flash in use for details.
- Multi-flash photography in the TTL Auto Flash mode can be done by combining the RTF with the AF400FTZ. In this case, the AF400FTZ attached to the camera's hot shoe has a priority for different functions over the RTF. When combining conventional dedicated flash units, use the lens aperture ring to select the aperture. Be sure to check the flash-ready indicator of the attached flash unit before shooting.
- The TTL Auto Flash or Programmed Auto Flash mode can be used even when the camera is set at the "100" (1/100 sec.) or "B" (bulb) settings.



## EXPOSURE MEMORY LOCK

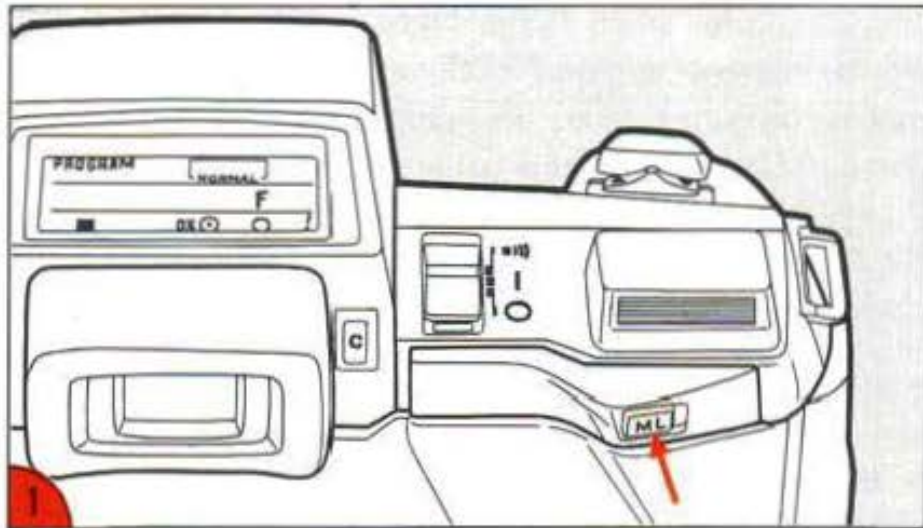

The exposure memory lock is a mechanism that temporarily memorizes exposure data measured before a shutter release in the AE modes. It is very useful when photographing subjects against strong backlight or when there is a large, extremely bright or dark background area.

1. Move in to capture the main subject (a person's face, for example) in full frame in the viewfinder and then press the exposure memory lock button [ML] to memorize the exposure data. The viewfinder indicators will blink rapidly to indicate the function is operating.

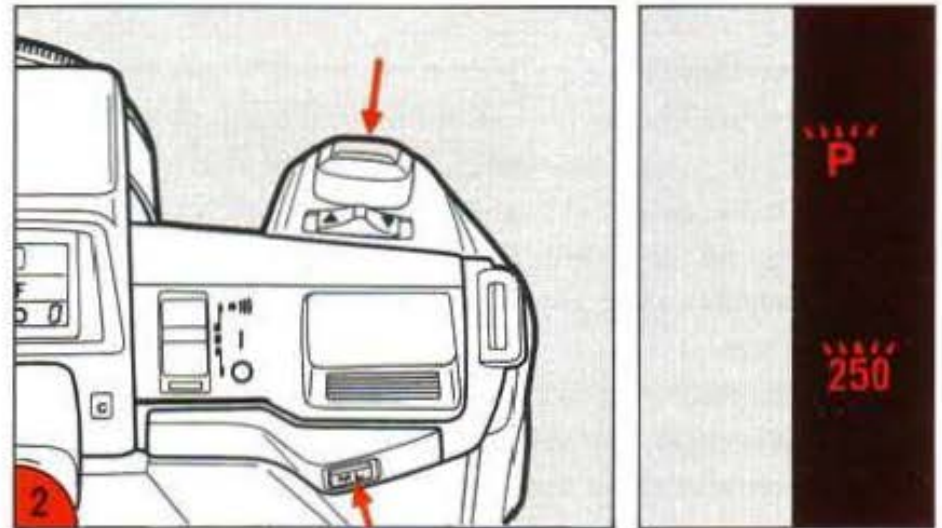

2. To extend the exposure memory, press the shutter release button halfway down while also pressing the ML button. As long as the shutter release button is held at this position, the measured exposure data is kept in memory.  
Move back, recompose the image and release the shutter. The subject is correctly exposed. Once the shutter is released, the memory is canceled.

### Precaution

- If the ML button is pressed while the camera is in the Metered Manual mode, the shutter speed indicator in the viewfinder locks and starts blinking.

## SELF-TIMER

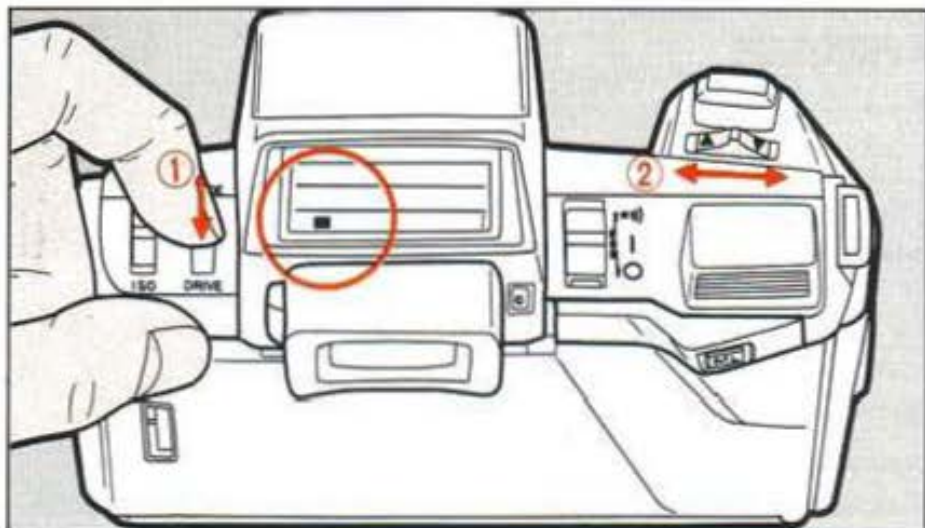

Take advantage of the self-timer when you wish to be in your own photograph.

Set the self-timer by sliding the select switch to the UP or DOWN position while holding the mode/drive switch at the DRIVE position. The [☺] mark on the CENTIC panel will light up. After focusing on the subject, press the shutter release button. This delays the shutter release for approximately 12 seconds.

- If the main switch is set at the [•••] position, self-timer operation is indicated not only by the LED self-timer indicator but also a PCV tone. For the final two seconds before the shutter release, the indicator blinks and the PCV tone changes to a short, intermittent beep.

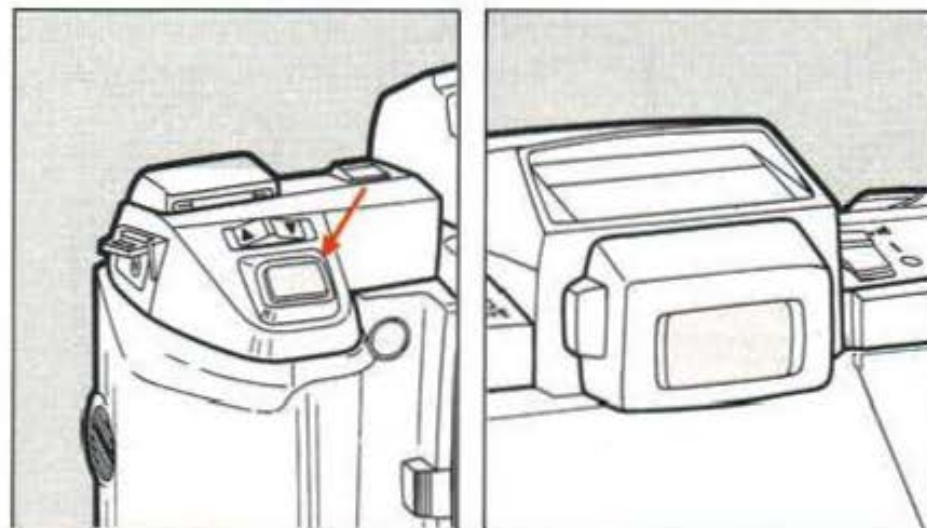

- The exposure-frame/self-timer counter on the CENTIC panel counts down the delay time from 12 seconds to shutter release.
- To cancel the self-timer operation, turn the main switch off.
- The self-timer cannot be used in combination with the bulb setting.

Since your eye isn't covering the viewfinder when you use the self-timer, light entering the eyepiece can cause exposure errors (underexposing the subject) in the AE modes. To prevent such errors, remove the Hot Shoe Cover F from the hot shoe and insert it inside the Eyecup F.



# EXPOSURE COMPENSATION

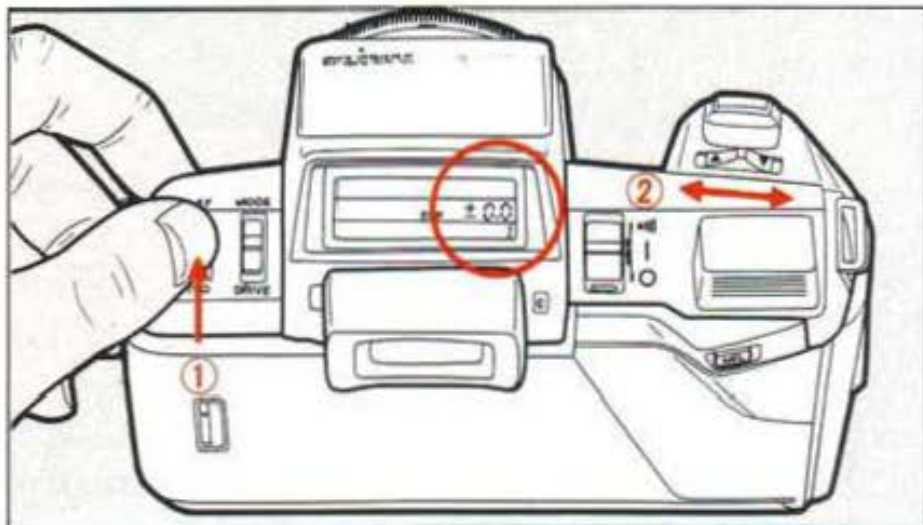

The exposure compensation system is used to change the basic exposure value or to intentionally under- or overexpose the subject in the AE modes.

Sample Subjects	Compensation Value
<ul style="list-style-type: none"> <li>• Back-lit subjects</li> <li>• Landscapes with a large amount of blue sky</li> <li>• Person(s) on the snow</li> <li>• Person(s) with the sky in background</li> </ul>	Approx. +1 to +3.5 EV
<ul style="list-style-type: none"> <li>• Subjects with dark background</li> <li>• Subjects on stage</li> <li>• Night scenes</li> </ul>	Approx. -1 to -3.5V

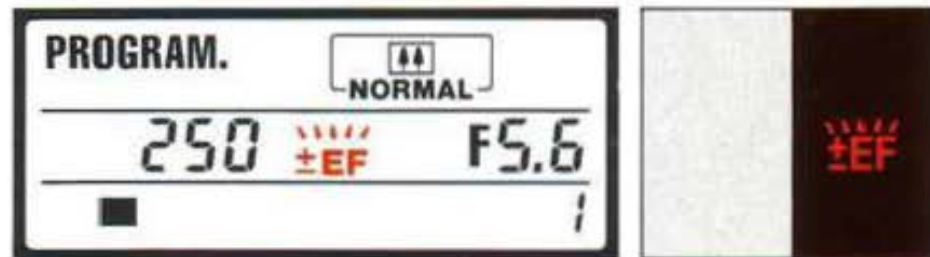

To use the exposure compensation feature, set the desired compensation value by sliding the select switch to the UP or DOWN position while holding the ISO/exposure compensation switch at the  $\pm EF$  position.

The exposure value can be adjusted in the range between -4 EV and +4 EV in 1/2 steps.

The exposure compensation mark [ $\pm EF$ ] on the CENTIC panel blinks while the exposure compensation is being used. When you press the shutter release button halfway down, the  $\pm EF$  indicator in the viewfinder blinks.

Be sure to reset the value to "0.0" by pushing the exposure mode clear button as soon as you finish using the feature.

- Exposure compensation can also be used in combination with the TTL Auto Flash or Programmed Auto Flash mode.
- In the Metered Manual mode, it is easier to change the shutter speed or aperture after obtaining the correct exposure.

▲ UP position	←	→	▼ DOWN position	
+4.0	~	±0.0	~	-4.0
(Displayed in 1/2 steps)				

±0.0



+2.0



±0.0



-2.0





## B (BULB) AND 100 (1/100 SEC.) SETTINGS

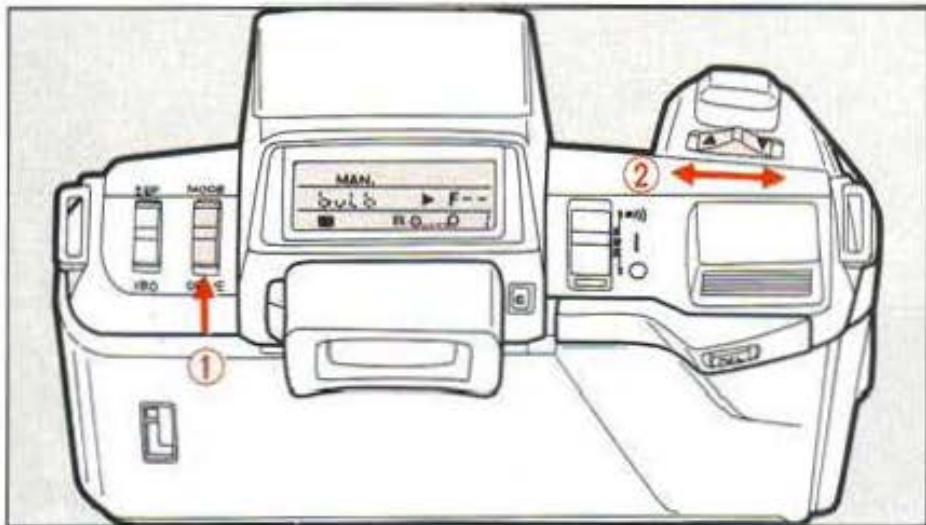

Select the "B" (bulb) or "100" (1/100 sec.) setting by sliding the select switch to the UP or DOWN position while holding the mode/driver switch at the MODE position. The appropriate indicator will appear on the CENTIC panel. When you press the shutter release button halfway down, the indicator "M" will appear in the viewfinder.

### Using the "B" (Bulb) Setting

Use this setting for long-time exposures of subjects such as fireworks and night scenes. The shutter remains open as long as the shutter release button is held down.

- When using the bulb setting, stabilize the camera with a solid tripod and connect the optional Cable Switch F (with a lock mechanism) to the camera's release socket, as illustrated.

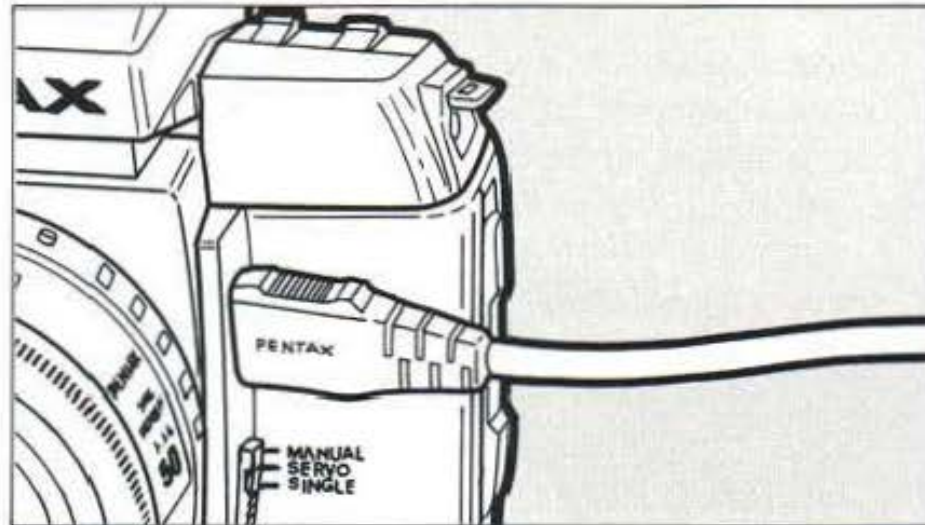

- With one fresh 6V lithium battery or four fresh "AA"-size alkaline batteries, a long-time exposure of approximately 7 hours is possible under normal temperatures.

### Using the "100" (1/100 sec.) Setting

This setting is used for flash photography using a general clip-on type flash unit with a fixed shutter speed of 1/100 second.

- When using a general clip-on type flash unit, the aperture must be set manually with the lens aperture ring according to the ISO speed of the film in use, the distance to the subject and the flash's guide number. (See the operating manual of the flash unit concerned.)



## INFRARED INDEX

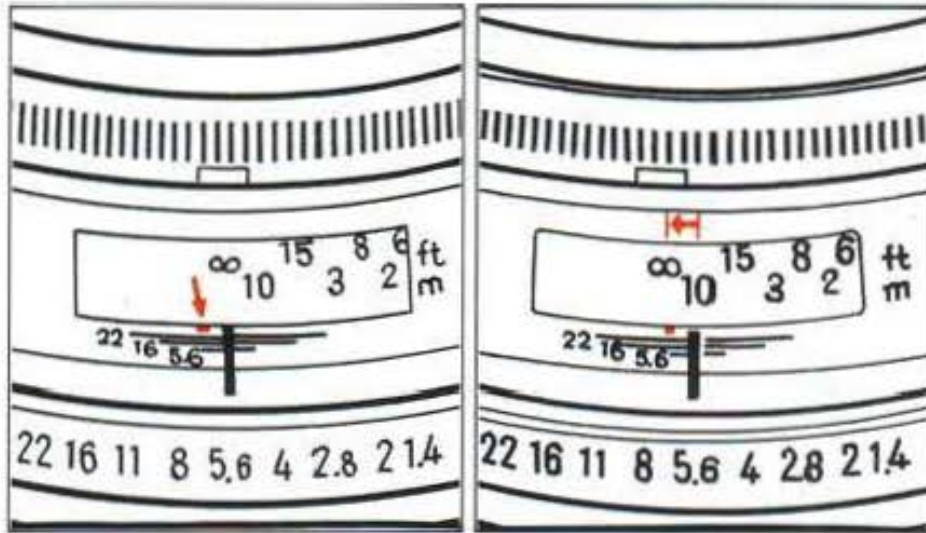

In infrared photography when using infrared film and an R2 or O2 filter, you need to adjust the focusing to compensate for infrared rays, which are different from the visible rays of normal photography.

As illustrated at left, memorize the subject's distance indicated on the lens distance scale after focusing, then turn the focusing ring to align that distance setting with the red infrared index before shooting. (See the film's instructions for exposure settings.)

- Be sure to set the focus-mode switch at the MANUAL position before turning the focusing ring manually.

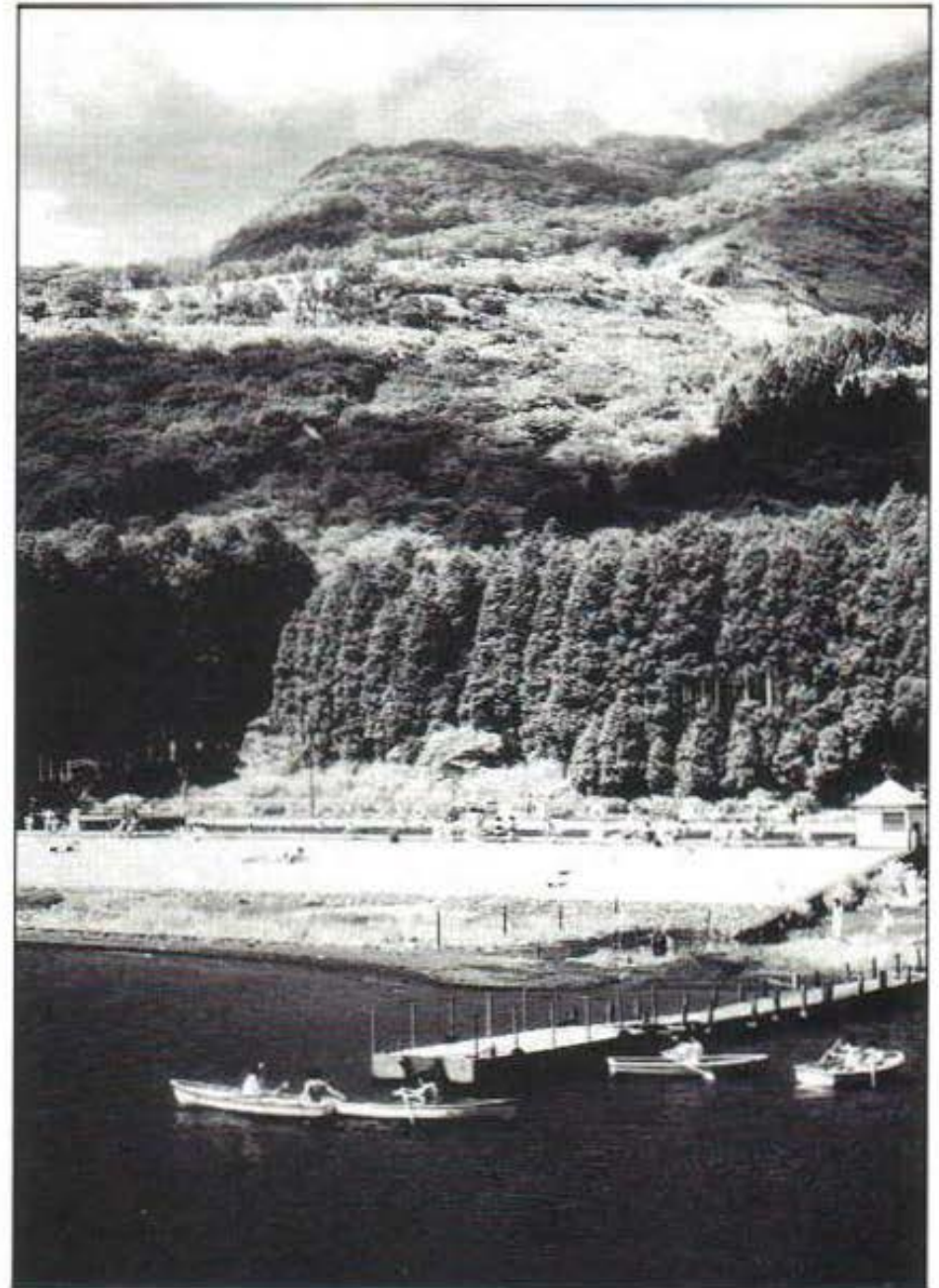



# DEPTH OF FIELD

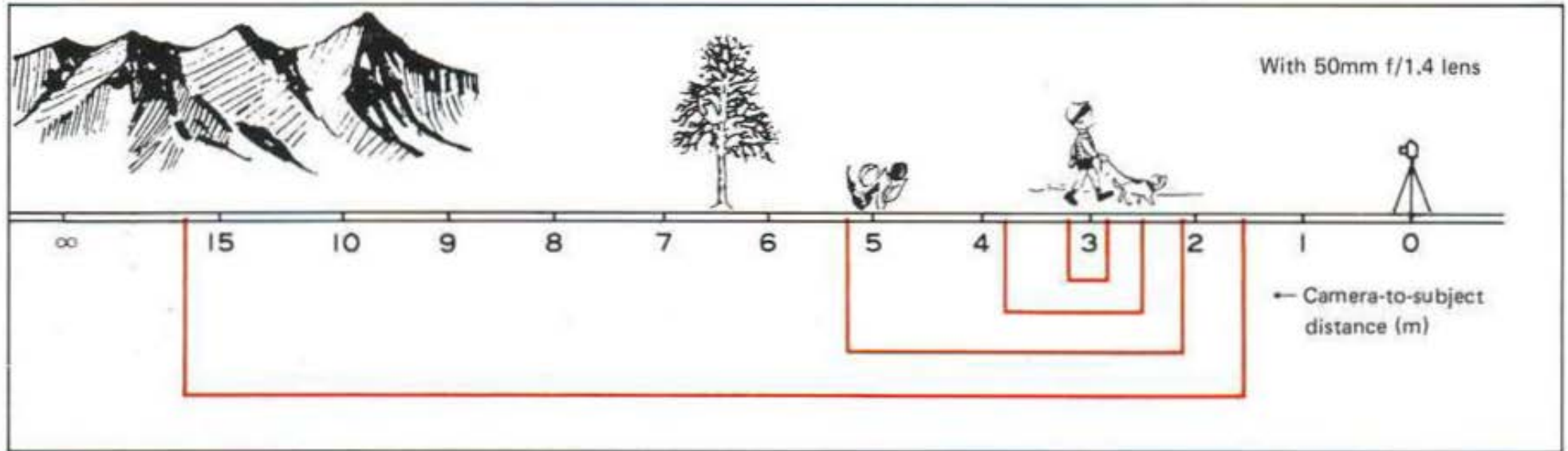

Depth of field refers to the range around the optimum focusing point of the subject in which the elements at different distances are in focus.

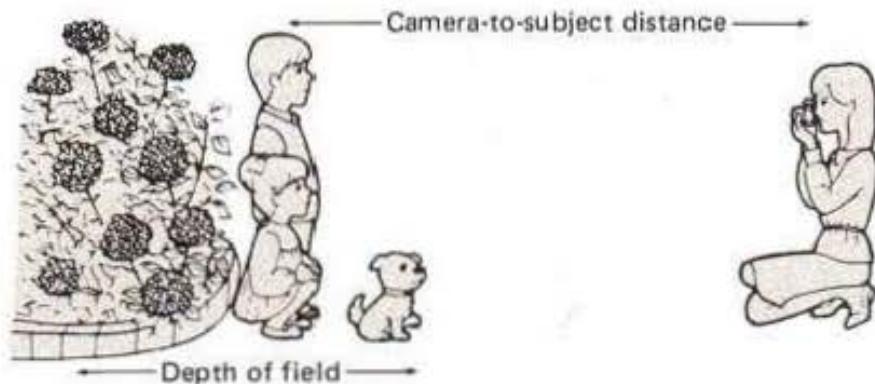

The depth of field increases as the aperture becomes smaller, as the focal length of the lens becomes shorter, and as the subject is positioned farther away. By changing apertures, you can control the depth of field and create different visual effects.

As illustrated in the examples at right (using f/1.4 and f/22 settings), the in-focus range can be confirmed by the depth-of-field scale on the lens.

\* Some zoom lenses do not have a depth-of-field scale due to mechanical reasons.

Aperture set at f/1.4 (2.85m~3.16m)

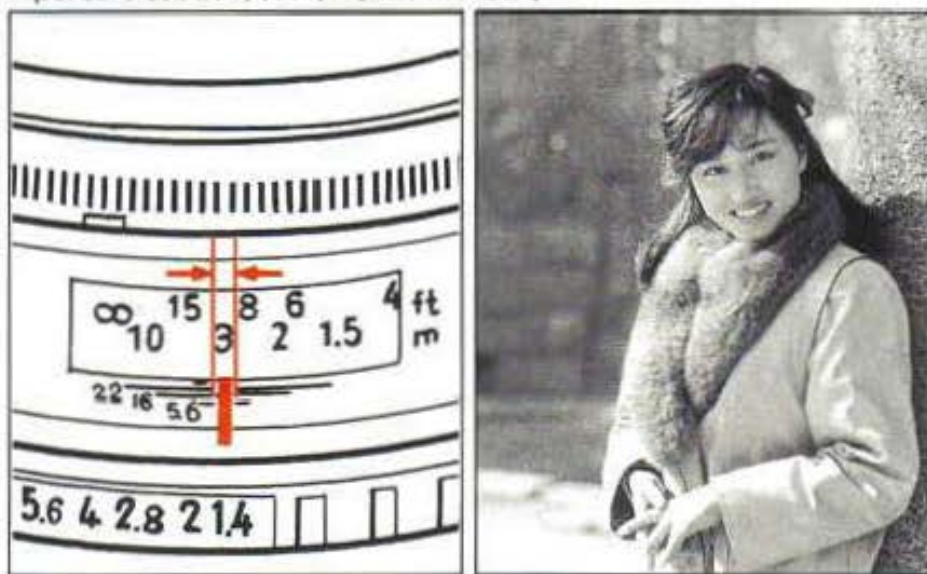

Aperture set at f/22 (1.6m~16.88mm)

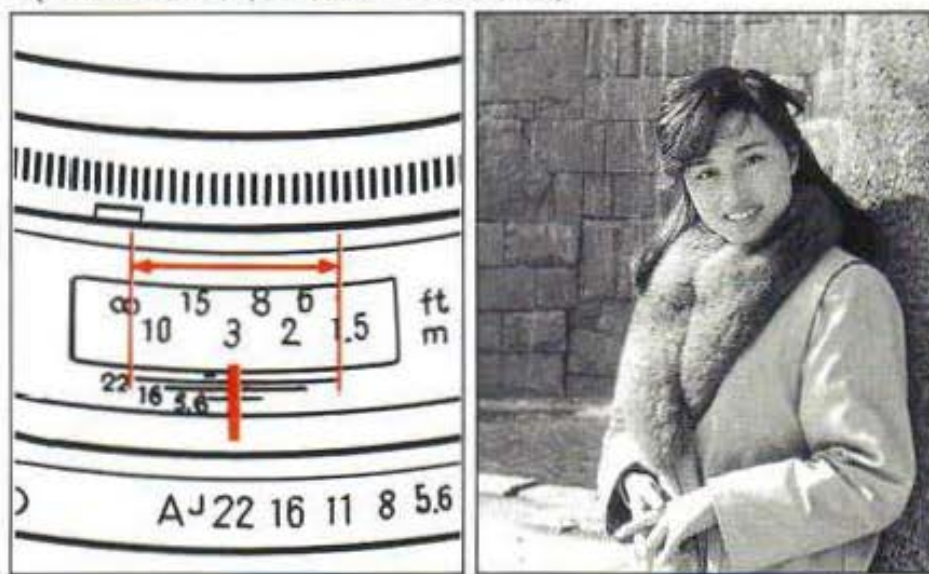

### Depth-of-field Table: SMC Pentax-F 50mm Lens

unit-meter

Distance scale	f/1.4	f/2	f/2.8	f/4	f/5.6	f/8	f/11	f/16	f/22
0.45m	~ 0.448 ~ 0.453	~ 0.446 ~ 0.454	~ 0.445 ~ 0.455	~ 0.443 ~ 0.457	~ 0.440 ~ 0.460	~ 0.436 ~ 0.465	~ 0.431 ~ 0.471	~ 0.423 ~ 0.481	~ 0.414 ~ 0.493
0.5m	~ 0.497 ~ 0.503	~ 0.495 ~ 0.505	~ 0.494 ~ 0.507	~ 0.491 ~ 0.509	~ 0.487 ~ 0.513	~ 0.482 ~ 0.519	~ 0.476 ~ 0.527	~ 0.466 ~ 0.540	~ 0.454 ~ 0.557
0.6m	~ 0.595 ~ 0.605	~ 0.593 ~ 0.607	~ 0.590 ~ 0.610	~ 0.586 ~ 0.615	~ 0.581 ~ 0.621	~ 0.573 ~ 0.630	~ 0.564 ~ 0.642	~ 0.549 ~ 0.663	~ 0.532 ~ 0.691
0.8m	~ 0.791 ~ 0.810	~ 0.787 ~ 0.814	~ 0.781 ~ 0.820	~ 0.774 ~ 0.828	~ 0.764 ~ 0.840	~ 0.749 ~ 0.859	~ 0.732 ~ 0.883	~ 0.705 ~ 0.927	~ 0.675 ~ 0.987
1.0m	~ 0.985 ~ 1.016	~ 0.978 ~ 1.023	~ 0.970 ~ 1.032	~ 0.958 ~ 1.046	~ 0.942 ~ 1.066	~ 0.919 ~ 1.098	~ 0.892 ~ 1.140	~ 0.851 ~ 1.218	~ 0.806 ~ 1.328
1.5m	~ 1.464 ~ 1.538	~ 1.449 ~ 1.555	~ 1.430 ~ 1.578	~ 1.402 ~ 1.613	~ 1.366 ~ 1.664	~ 1.316 ~ 1.746	~ 1.259 ~ 1.861	~ 1.174 ~ 2.093	~ 1.086 ~ 2.462
2.0m	~ 1.935 ~ 2.070	~ 1.908 ~ 2.101	~ 1.874 ~ 2.144	~ 1.825 ~ 2.213	~ 1.764 ~ 2.312	~ 1.679 ~ 2.478	~ 1.584 ~ 2.724	~ 1.449 ~ 3.265	~ 1.314 ~ 4.298
3.0m	~ 2.853 ~ 3.164	~ 2.794 ~ 3.239	~ 2.719 ~ 3.346	~ 2.615 ~ 3.521	~ 2.487 ~ 3.785	~ 2.318 ~ 4.265	~ 2.137 ~ 5.073	~ 1.892 ~ 7.426	~ 1.665 ~ 16.883
10.0m	~ 8.488 ~ 12.171	~ 7.973 ~ 13.421	~ 7.375 ~ 15.552	~ 6.631 ~ 20.422	~ 5.846 ~ 35.101	~ 4.966 ~ ∞	~ 4.181 ~ ∞	~ 3.313 ~ ∞	~ 2.655 ~ ∞
∞	~ 55.370 ~ ∞	~ 38.772 ~ ∞	~ 27.707 ~ ∞	~ 19.408 ~ ∞	~ 13.876 ~ ∞	~ 9.726 ~ ∞	~ 7.086 ~ ∞	~ 4.885 ~ ∞	~ 3.565 ~ ∞



## INTERCHANGEABLE FOCUSING SCREENS

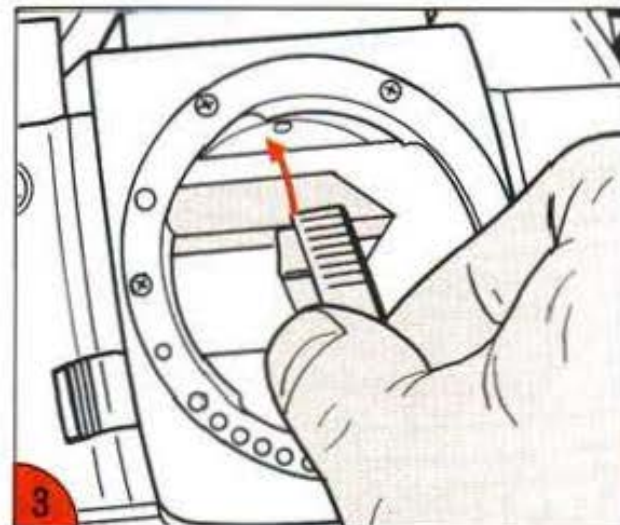
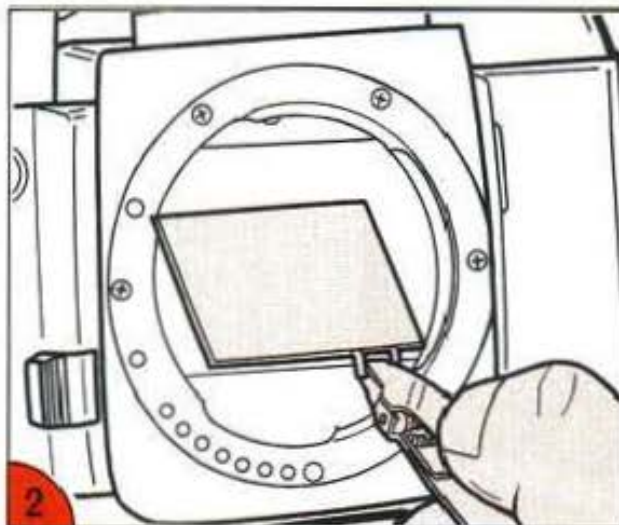
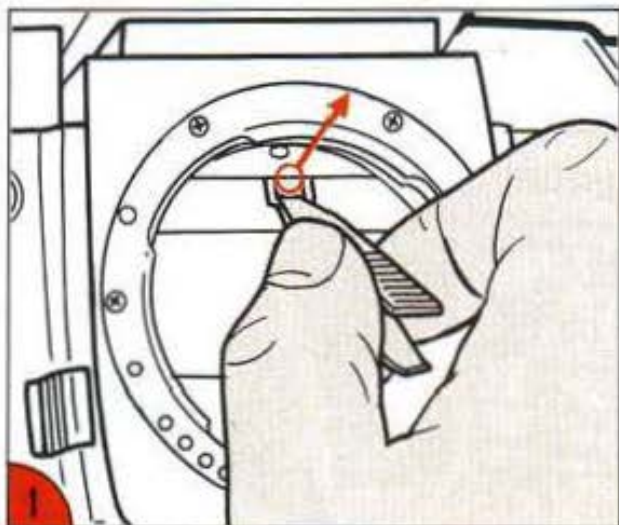

In addition to the standard all-surface-matte focusing screen, two other optional screens are available. The screens can easily be changed by using a pair of tweezers included in the focusing screen's case.

1. As illustrated, the focusing screen hangs down when the pressure plate (behind the "O" mark) is pulled down (toward an arrow "→").
2. Take the screen out by grasping its projected part with the tweezers and stand it up at the groove of the case to avoid damages or scratches.
3. As illustrated, place the new screen on the frame with the tweezers and push the frame up until it locks with a click.



Scale Matte Screen (FD-41):  
for photomicrography and  
macrophotography.

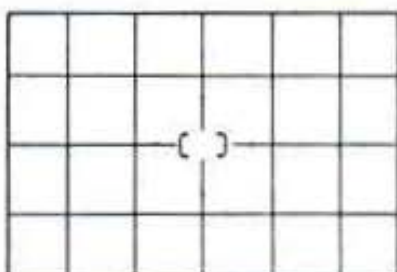

Cross-Lined Matte Screen  
(FG-40): for copying work  
and general-purpose  
photography.

The focusing screens are made of plastic. Be careful not to damage them when handling. To clean a screen, use a blower to blow away the dust.

## STRAP AND CASE

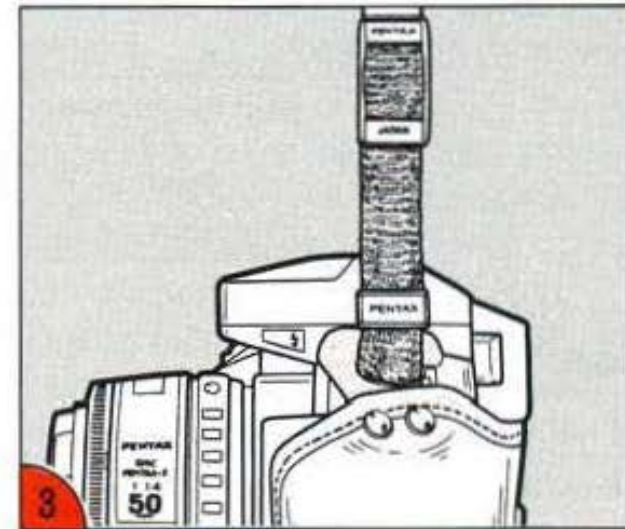
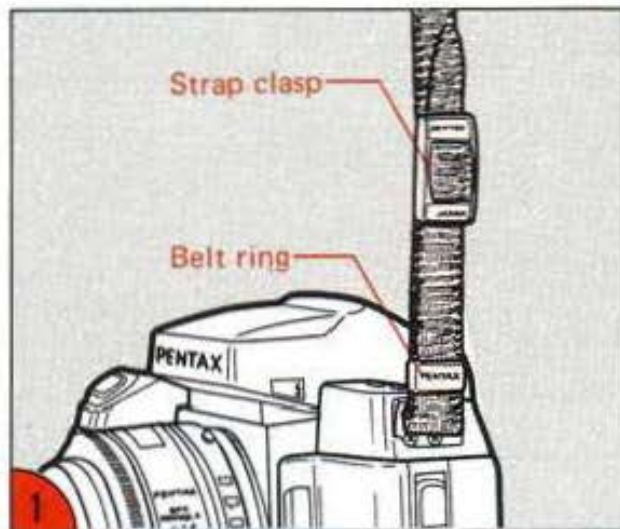

1. To attach the strap to the camera, first pass its end through the camera's strap lug, then fold it backwards. Next, pass it through the strap ring and the strap clasp, in that order. The end of the strap may be passed through the inside or outside of the clasp.
2. The soft case consists of a front and a back cover, which are connected by hooks.
3. Open up the front cover, and place the camera in the back cover. The camera is firmly secured in the case by hooking up the back cover's hook with the front cover's fitting.

- A soft case is available as an option, and consists of a back cover and two different front covers (small and large).

Small front cover: for a camera with a standard lens (such as the Zoom 35mm—70mm).

Large front cover: for a camera with a telephoto zoom lens (such as the Zoom 70mm — 210mm).

- A back cover for a camera equipped with an accessory data back is also available as an option.



## CAMERA'S COMPATIBILITY WITH PENTAX LENSES

Camera's Functions	Exposure Mode		Focusing Mode			
	Programmed AE Shutter- Priority AE	Aperture- Priority AE Metered Manual	Auto Focus (AF SINGLE/AF SERVO)		Manual Focus	
				With AF Adapter 1.7X	FI System	Matte Screen Focusing
<b>SMC Pentax Lenses</b>						
F-series lenses	○	○	○	—	○	○
A-series lenses	○	○	x	○*	○*	○
M-series lenses	x	○	x	○*	○*	○
Pentax lenses	x	○	x	○*	○*	○
Takumar lenses	x	○*	x	x	x	○

### The lenses have the following limitations:

- Only lenses with a maximum aperture of f/5.6 or larger can be used with the FI (Focus Indication) system of the manual focusing mode.
- Only lenses with a maximum aperture of f/2.8 or larger can be used in the auto-focusing mode in combination with the AF Adapter 1.7X. (See the AF Adapter 1.7X's operating manual for more detailed information.)
- \* Can be used only in the stop-down metering.

- The FI (Focusing Indication) system of the manual focusing mode indicates the in-focus point with an LED indicator in the viewfinder and a PCV (piezo-ceramic vibration) tone. The camera automatically selects the manual focusing mode for all the lenses other than the F-series lenses no matter what position the focus mode switch is set to.
- Matte-screen focusing can be done in the viewfinder area excluding its central portion, regardless of the focus indication. When the Takumar lens is used, the focus indicator does not work.

## PRECAUTIONS ON BATTERIES

- Always handle batteries properly. Incorrect handling or use may result in leakage, heat generation and explosion. Always check the batteries' polarity markings when inserting them.
- When replacing batteries, do not mix battery brands and types, or old batteries with new ones.
- When you will not be using the camera for a long period of time, remove the batteries from it. Old batteries are apt to leak and can cause damage to the battery compartment.
- Never try to break, recharge or throw used batteries into a fire; they can explode.
- Keep the batteries warm in cold locations to ensure a stable power supply and to prevent camera malfunctions.
- Carry a spare set of new batteries during trips and when photographing outdoors.
- When keeping the camera in a bag or case, be sure to turn the main switch off to avoid accidental shutter releases and unnecessary battery consumption.
- When the RTF is used continuously, the lithium battery may become slightly warm. This is natural, and nothing to worry about.
- With one fresh 6V lithium battery or four fresh "AA"-size alkaline batteries, approximately 55 rolls of 24-exposure film can be exposed (under the experimental conditions of the Pentax laboratory).

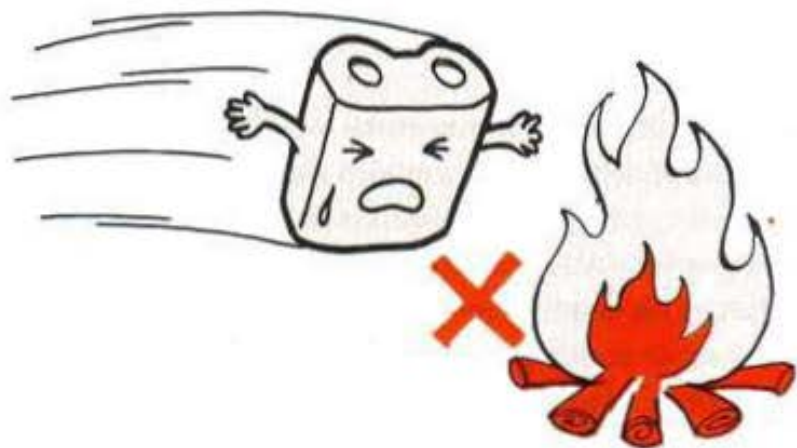



## TAKING CARE OF YOUR CAMERA

Your Pentax camera is a sophisticated, precision instrument built to give long-lasting, reliable service. It will serve you well if you treat it right, with proper handling and reasonable care. The major cause of damage are:

1. Dropping or banging the camera against immovable objects, which can damage the camera in many ways.
2. Water damage, particularly if the camera is submerged in salt water. Your camera is not water-proof! It must be protected from salt breeze, salt spray at the beach, splashing of any kind, and shielded from the rain. If your camera does get soaked, wipe it dry immediately and rush it to a Pentax service center.

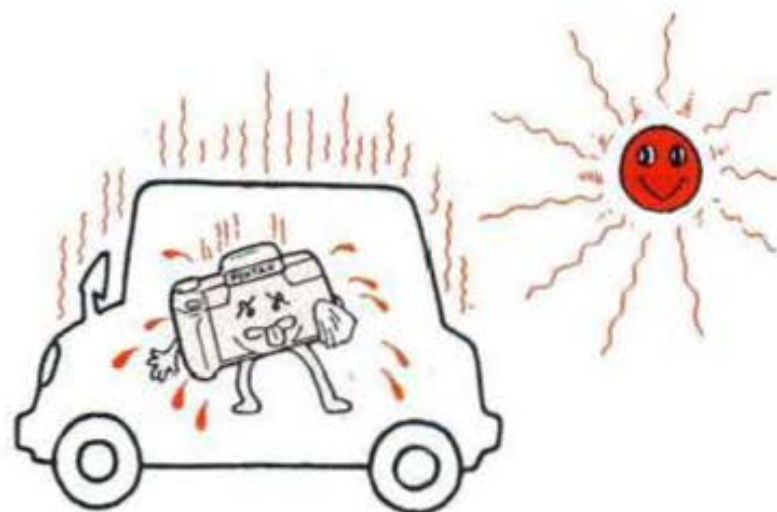

3. Dirt and sand can cause serious damage to the shutter and other moving parts of the camera. Your camera needs periodic cleaning to keep it operating properly. To remove dirt and dust, you need lens-cleaning fluid, lens-cleaning tissues, bulb-type ear syringe, camel's hair-brush, etc. Never use a solvent such as thinner or alcohol.
4. Humidity and temperature extremes should be avoided. Keep your camera out of direct sunlight, car trunks, and glove compartments. Shooting outdoors in winter presents a problem since batteries won't function if they get too cold. In cold weather carry your camera under your coat or jacket to keep the batteries warm. The temperatures at which this camera should function properly are approx. 50°

~-10°C. Sudden changes in temperature will often cause moisture to condense inside or outside your camera. This is a possible source of rust, which may be extremely harmful to the mechanism.

Furthermore, if the camera is taken from a warm temperature to a sub-freezing one, further damage may result from the formation of icelets. Thus, sudden temperature changes should be avoided as much as possible. As a guide, a temperature change of 10°C should be allowed to take place gradually over a period of at least 30 minutes. If this is not possible, keeping the camera in its case or bag will help somewhat in minimizing the effects of a rapid temperature change.

5. Vibration experienced when you are traveling in a car, plane, or ship, can cause screws to loosen. To minimize this problem use foam-rubber padding about one inch thick to line the bottom of your camera bag.
6. When mounting your camera on a tripod, make sure the tripod screw is no longer than 5.5mm, which is the depth of your camera's tripod socket. If you use a longer screw, you will possibly puncture the tripod socket, after which the camera will not function properly.

#### **Precautions on CENTIC Panel's LCD Display**

- In temperatures over approximately 60°C, the CENTIC panel's LCD display may darken. It will return to its normal condition under normal temperatures.
- In low temperatures, the LCD display may respond more slowly. This is due to the characteristics of the liquid used and is not a malfunction.
- When a battery grip is detached, the CENTIC panel shows its entire display. It will return to its normal display condition after proper operation is resumed.

#### **Backup Circuits for LCD Display**

Even when the battery is removed for replacement during shooting, the built-in backup circuits retains data such as the frame number and the ISO film speed in memory until a new battery is inserted.



## SPECIFICATIONS

<b>Type:</b>	TTL auto-focus, multi-program, fully-automatic 35mm SLR with built-in TTL auto flash.
<b>Film:</b>	35mm cartridge film. DX-coded film with ISO 25–5000; non-DX-coded film with ISO 6–6400 in 1/3 steps.
<b>Exposure modes:</b>	Programmed AE (Normal Program, Program Action, Program Depth), Aperture-Priority AE, Shutter-Priority AE, and Metered Manual.
<b>Shutter:</b>	Electronically-controlled vertical-run focal-plane shutter. Programmed AE and Aperture-Priority AE from 1/2000 to 1/30 sec. Shutter-Priority and Metered Manual from 1/2000 to 1 sec. Flash sync at 1/100 sec. Shutter lock with main switch off.
<b>Lens mount:</b>	Pentax KAF mount with AF coupler and lens-information contacts.
<b>Lens:</b>	SMC Pentax-F lenses (K- and KA-mount lenses with maximum aperture of f/5.6 or faster usable in Focus-Indication mode, and also ones with maximum aperture of f/2.8 or faster usable in AF mode through aid of AF Adapter 1.7X).
<b>Focusing modes:</b>	AF SINGLE, AF SERVO and MANUAL-focus modes. Focusing system: Pentax TTL phase-matching auto-focus system. Usable illumination range from EV 2 to EV 18 at ISO 100. Focusing response: approx. 0.3 sec. from infinity to minimum focus distance (0.7m) using SMC Pentax-F 35–70mm zoom lens. Effective range of AF Spotbeam Projector: 1 to 4 meters.
<b>Viewfinder:</b>	Pentaprism with diopter-adjustment mechanism. 92% field of view. 0.81 magnification with 50mm lens set at infinity. Diopter adjustment ranges from -1.5 to +1.5 Diopters. Interchangeable Clear-Bright-Matte focusing screens.
<b>Viewfinder LED indications:</b>	Focus information: in-focus, front-focus and back-focus signals. Exposure information: Programmed AE, Aperture-Priority / Shutter-Priority AE, Metered Manual, shutter speed, exposure compensation and flash readiness / flash exposure confirmation for dedicated accessory flash.
<b>External LCD (CENTIC) indications:</b>	Programmed AE, Program Action, Program Depth, Normal Program (Wide, Tele, Standard), Aperture-Priority / Shutter-Priority AE, Metered Manual, Bulb, X-sync, shutter speed / Bulb / ISO film speed, manual ISO override, exposure compensation, exposure compensation / aperture value, film-wind / rewind, motor drive mode, battery warning, self-timer, DX-coded film and exposure frame / self-timer counter.

<b>Self-timer:</b>	Electronically-controlled type. 12-sec. delay time. Start by shutter release button. Operation confirmation by LED indicator, PCV sound and CENTIC panel. Cancellation by exposure-mode-clear button or main switch off.
<b>Mirror:</b>	Swing-up-type instant-return mirror with AF secondary mirror.
<b>Film advance / rewind:</b>	Auto wind / rewind and auto rewind stop by built-in wind motor. Consecutive or single advance mode. Approx. 1.8-frame-per-second advance speed.
<b>Exposure control:</b>	TTL center-weighted, averaged-area metering by GPD cell. Metering range from EV 1 to EV 20 at ISO 100 with 50mm f/1.4 lens.
<b>Exposure compensation:</b>	EV -4 to EV 4 in 1/2 steps.
<b>Exposure- memory lock:</b>	By exposure-memory-lock (ML) button.
<b>Built-in flash:</b>	Parallel-controlled retractable TTL Auto Flash (RTF) with AF Spotbeam Projector. Guide number: 14 (ISO 100 in meters). Covers angle of view for 35mm wide-angle lens.
<b>Flash sync:</b>	Via hot shoe with X-contact which couples with Pentax dedicated auto flashes.
<b>Power source:</b>	One 6V lithium battery pack for standard Lithium Battery Grip, or four 1.5V AA-size alkaline batteries for optional AA-size Battery Grip.
<b>Low battery warning:</b>	By blinking battery warning mark in CENTIC panel and blinking viewfinder LED under standard voltage supply.
<b>Back cover:</b>	Interchangeable for accepting Data Back F or Interval Data Back F.
<b>Dimensions/ weight:</b>	157(W) x 99(H) x 63.5(D)mm (6.1 x 3.9 x 2.5 in.). 665 grams (23.3 oz) without batteries.
<b>Standard accessories:</b>	Hot-shoe cover, Release-socket cap F, Eyecup F, Body-mount cover F, and Camera strap F.



All Pentax cameras purchased through authorized bona fide photographic distribution channels are guaranteed against defects of material or workmanship for a period of twelve months from date of purchase. Service will be rendered and defective parts will be replaced without cost to you within that period, provided the equipment does not show evidence of impact, sand or liquid damage, mishandling, tampering, battery or chemical corrosion, operation contrary to operating instructions, or modification by an unauthorized repair shop. Because the tolerances, quality, and design compatibility of lenses other than Pentax lenses are beyond our control, damage caused by use of such lenses will not be covered by this warranty policy. The manufacturer or its authorized representatives shall not be liable for any repair or alterations except those made with its written consent and shall not be liable for damages from delay or loss of use or from other indirect or consequential damages of any kind, whether caused by defective material or workmanship or otherwise; and it is expressly agreed that the liability of the manufacturer or its representatives under all guarantees or warranties, whether express or implied, is strictly limited to the replacement of parts as hereinbefore provided. No refunds will be made on repairs performed by non-authorized Pentax service facilities.

### Procedure During 12-month Warranty Period

Any Pentax which proves defective during the 12-month warranty period should be returned to the dealer from whom you purchased the equipment or to the manufacturer. If there is no representative of the manufacturer in your country, send the equipment to the manufacturer, with postage prepaid. In this case, it will take a considerable length of time before the equipment can be returned to you owing to the complicated customs procedures required in Japan in importing and re-exporting photographic equipment. If the equipment is covered by warranty, repairs will be made and parts replaced free of charge, and the equipment will be returned to you upon completion of servicing. If the equipment is not covered by warranty, regular charges of the manufacturer or of its representatives will apply. Shipping charges are to be borne by the owner. If your Pentax was purchased outside of the country where you wish to have serviced during the warranty period, regular handling and servicing fees may be charged by the manufacturer's representatives in that country. Notwithstanding this, your Pentax returned to the manufacturer will be serviced free of charge according to this procedure and warranty policy. In any case, however, shipping charges and customs clearance fees are to be borne by the sender. To prove the date of your purchase when required, please keep the receipts or bills covering the purchase of your equipment for at least a year.

Before sending your equipment for servicing, please make sure that you are sending it to the manufacturer's authorized representatives or their accredited repair shops, unless you are sending it directly to the manufacturer. Always obtain a quotation of the service charge, and only after you accept the quoted service charge, instruct the service station to proceed with the servicing.

**This warranty policy does not apply to Pentax products purchased in the U.S.A., U.K., or Canada. The local warranty policies available from Pentax distributors in those countries supersede this warranty policy.**



# NOMENCLATURE

- 34 Film chamber
- 35 Rewind shaft
- 36 Shutter curtains
- 37 Flash-ready lamp
- 38 Eyecup F

- 39 Diopter-adjustment slide
- 40 Viewfinder eyepiece
- 41 Viewfinder-accessory groove
- 42 Exposure-mode-clear button
- 43 Exposure-memory-lock button
- 44 Film-information window

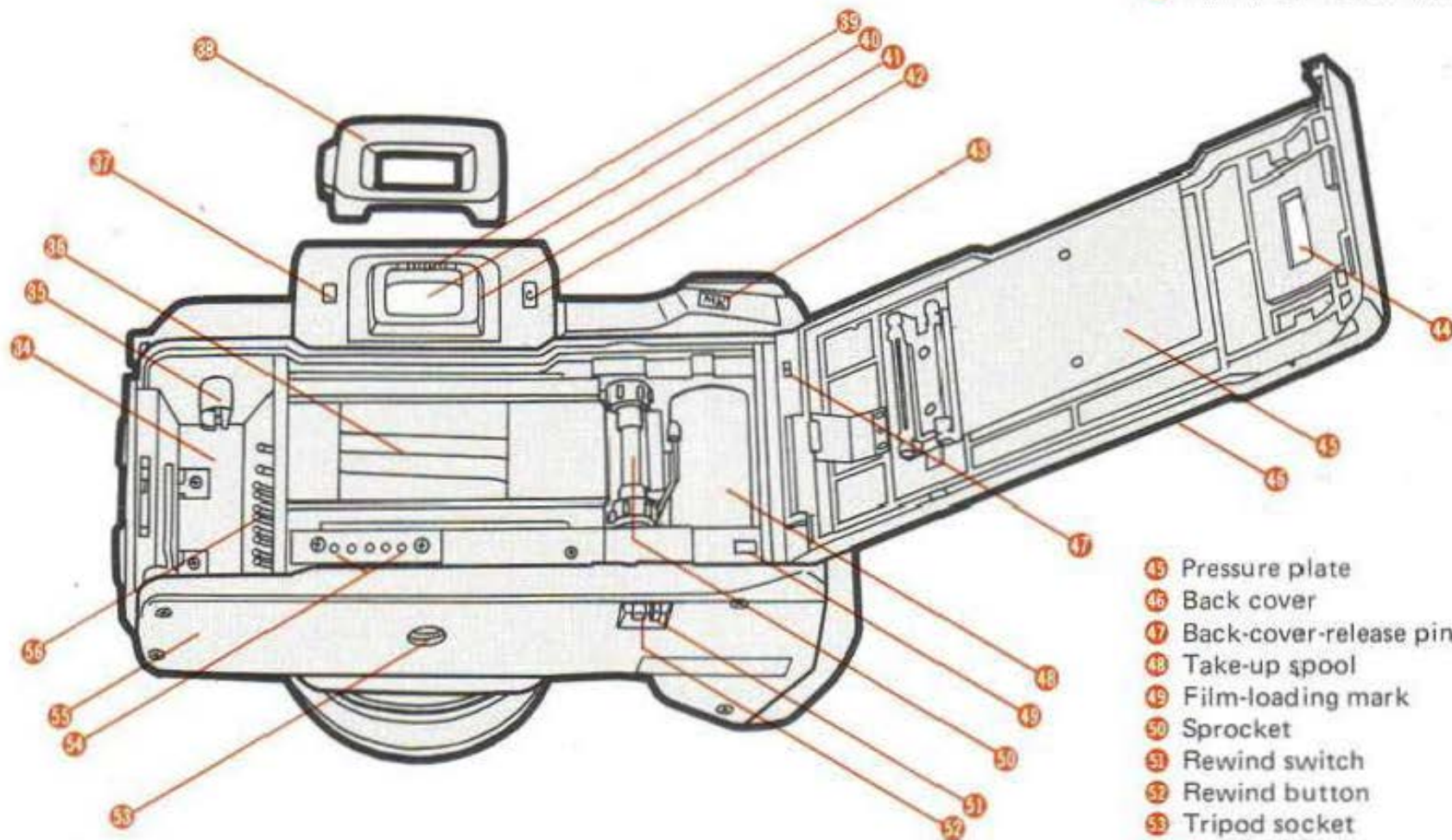

- 45 Pressure plate
- 46 Back cover
- 47 Back-cover-release pin
- 48 Take-up spool
- 49 Film-loading mark
- 50 Sprocket
- 51 Rewind switch
- 52 Rewind button
- 53 Tripod socket
- 54 Cordless contacts
- 55 Bottom cover
- 56 DX-information pins









Asahi Optical Co., Ltd C.P.O. 895, Tokyo 100-91, JAPAN  
Pentax Europe N.V. Weiveldlaan 3-5, 1930 Zaventem, BELGIUM  
Pentax Handelsgesellschaft mbH. Postfach 54 0169, 2000 Hamburg 54, WEST GERMANY  
Pentax U.K. Limited. Pentax House, South Hill Avenue, South Harrow, Middlesex HA2 OLT, U.K.  
Pentax France S.A. Z.I. Argenteuil 12, Rue Ambroise-Croizat, 95100 Argenteuil, FRANCE  
Pentax (Schweiz) AG Industriestrasse 2, CH-8305 Dietlikon, SWITZERLAND  
Pentax Scandinavia A.B. Box 650, S-751 27 Uppsala, SWEDEN  
Pentax Nederland Spinveld 25, 4815 HR Breda, THE NETHERLANDS  
Pentax Norge A/S P.B. 80, Lambertseter, 1101 Oslo 11, NORWAY  
Pentax Corporation 35 Inverness Drive East, Englewood, Colorado 80112, U.S.A.  
Pentax Canada Inc. 1760 West 3rd Avenue, Vancouver B.C. V6J 1K5, CANADA  
Asahi Optical Brasileira Ind. e Com. Ltda. R. Capitão Antonio Rosa 376, Sala 121 Ed. PBK, São Paulo, BRAZIL